



HARTNER

Precision Cutting Tools

MULTIPLX

INTERCHANGEABLE INSERT DRILLING SYSTEM
WITH INTERNAL COOLING

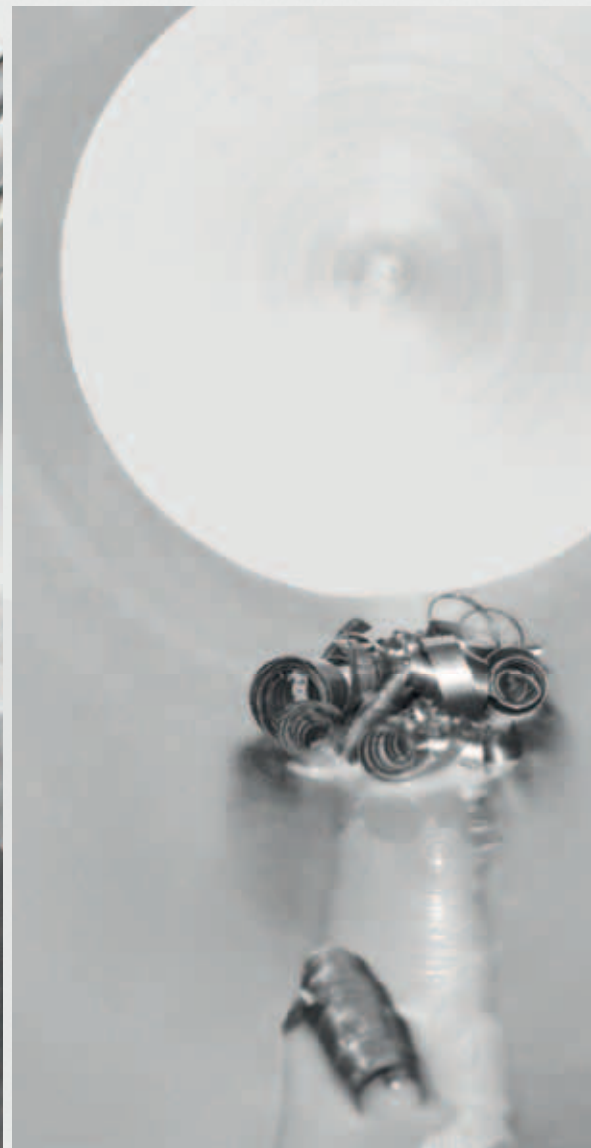
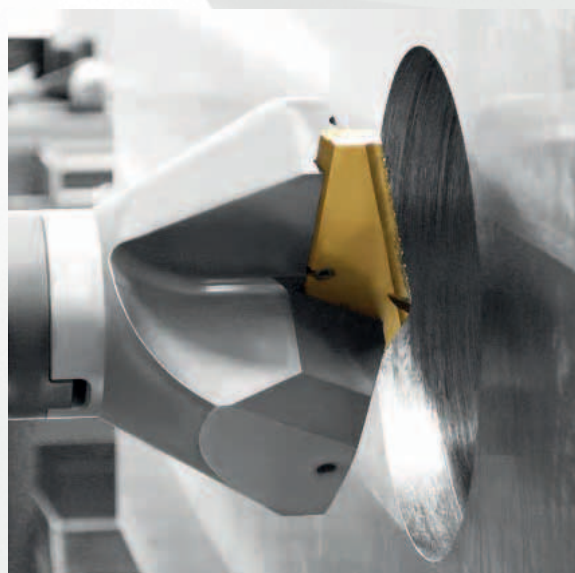

+ Edition 2022 + optimised holder design

P	M	K	N	S	H	Standard	Type	Tool material	Surface	Cutting direction	Internal cooling	Drilling depth	d1/mm	Article no.	Progr. page
---	---	---	---	---	---	----------	------	---------------	---------	-------------------	------------------	----------------	-------	-------------	-------------

Multiplex holder with straight shank



Company
std.



right-hand

with

3xD

9.500 - 54.000

86612

7



Company
std.



right-hand

with

5xD

9.500 - 54.000

86622

8



Company
std.



right-hand

with

7xD

9.500 - 54.000

86624

9



Company
std.



right-hand

with

13.157 - 89.845

86628

10

Multiplex holder with morse taper shank



Company
std.



right-hand

with

9.500 - 22.000

86630

13



Company
std.



right-hand

with

9.500 - 22.000

86650

14



Company
std.



right-hand

with

24.000 - 89.000

86670

15



Company
std.



right-hand

with

24.000 - 89.000

86680

16



Company
std.



right-hand

with

34.393 - 89.844

86678

17

P	M	K	N	S	H	Standard	Type	Tool material	Surface	Cutting direction	Internal cooling	Drilling depth	d1/mm	Article no.	Progr. page
---	---	---	---	---	---	----------	------	---------------	---------	-------------------	------------------	----------------	-------	-------------	-------------

Interchangeable inserts



•	○	•	○	○	○	Company std.		HSS-E-PM	T	right-hand			10.000 - 25.000	86602	20
---	---	---	---	---	---	--------------	--	----------	---	------------	--	--	-----------------	-------	----



○	•	○	•	•	○	Company std.		HSS-E	T	right-hand			25.000 - 102.000	86605	21
---	---	---	---	---	---	--------------	--	-------	---	------------	--	--	------------------	-------	----



•	○	•	○	○	○	Company std.		HSS-E-PM	F	right-hand			10.000 - 25.000	86608	22
---	---	---	---	---	---	--------------	--	----------	---	------------	--	--	-----------------	-------	----



•	○	•	○	○	○	Company std.		HSS-E-PM	A	right-hand			25.000 - 210.000	86609	23
---	---	---	---	---	---	--------------	--	----------	---	------------	--	--	------------------	-------	----



•	○	•	○	○	○	Company std.		HSS-E-PM	A	right-hand			10.000 - 65.000	86611	24
---	---	---	---	---	---	--------------	--	----------	---	------------	--	--	-----------------	-------	----



•	○	•	○	○	○	Company std.		Solid carbide	F	right-hand			10.000 - 35.000	86701	26
---	---	---	---	---	---	--------------	--	---------------	---	------------	--	--	-----------------	-------	----



•	○	•	○	○	○	Company std.		Solid carbide	F	right-hand			10.000 - 35.000	86702	27
---	---	---	---	---	---	--------------	--	---------------	---	------------	--	--	-----------------	-------	----



•	○	•	○	○	○	Company std.		Solid carbide	T	right-hand			10.000 - 35.000	86708	28
---	---	---	---	---	---	--------------	--	---------------	---	------------	--	--	-----------------	-------	----



•	○	•	○	○	○	Company std.		Solid carbide	T	right-hand			10.000 - 35.000	86709	29
---	---	---	---	---	---	--------------	--	---------------	---	------------	--	--	-----------------	-------	----



○	○	○	○	○	○	Company std.		Solid carbide	○	right-hand			10.000 - 65.000	86711	30
---	---	---	---	---	---	--------------	--	---------------	---	------------	--	--	-----------------	-------	----

P	M	K	N	S	H	Standard	Type	Tool material	Surface	Cutting direction	Internal cooling	Drilling depth	d1/mm	Article no.	Progr. page
---	---	---	---	---	---	----------	------	---------------	---------	-------------------	------------------	----------------	-------	-------------	-------------

Coolant supply ring



Company
std.

31.750 - 63.500

86690

32

Coolant supply pipe



Company
std.



13.160 - 20.960

82571

33

Quick release pipe union



Company
std.

9.000 - 13.000

82578

34

Torx screwdrivers



Company
std.

6.001 - 25.001

86842

35

Clamping screws for interchangeable inserts



Company
std.

2.000 - 5.000

86807

36

P	M	K	N	S	H	Standard	Type	Tool material	Surface	Cutting direction	Internal cooling	Drilling depth	d1/mm	Article no.	Progr. page
---	---	---	---	---	---	----------	------	---------------	---------	-------------------	------------------	----------------	-------	-------------	-------------

Coolant supply chuck for Multiplex



Company
std.

Ⓑ

86691

37



Company
std.

Ⓑ

86692

38



Company
std.

Ⓑ

86693

39



Company
std.

Ⓑ

86694

40

Reduction bushes for coolant supply chucks



Company
std.

Ⓑ

86699

41

MULTIPLEX HOLDER WITH STRAIGHT SHANK





Multiplex holder with straight shank

Article no. 86612



nickel-plated • Holder for interchangeable inserts. The straight shank holder possesses internal coolant supply. Wide flutes ensure optimal chip evacuation. Simple replacement of inserts via clamping screws. Adjustment of interchangeable inserts not necessary. The interchangeable inserted drill machines solid material. This drill is not suitable for drilling pre-cast or pre-drilled holes. Clamping screws art.-no. 86807 included.

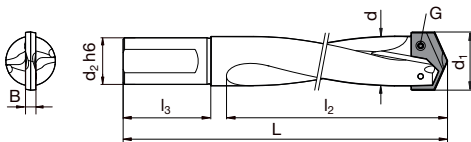

d1 mm	d mm	d2 mm	L mm	l2 mm	l3 mm	B mm	G	Code no.
10.00-11.7	9.500	20.000	108.000	50.000	40.000	2.500	86807 2.000	9.500
11.71-13.4	11.500	20.000	109.000	53.000	40.000	2.500	86807 2.000	11.500
13.41-16.4	13.000	20.000	116.000	60.000	40.000	3.500	86807 2.500	13.000
16.41-18.9	16.000	20.000	118.000	65.000	40.000	3.500	86807 2.501	16.000
18.91-22.4	18.500	20.000	124.000	73.000	40.000	4.000	86807 3.000	18.500
22.41-25.4	22.000	20.000	127.000	78.000	40.000	4.000	86807 3.001	22.000
25.41-29.0	24.000	32.000	178.000	105.000	60.000	5.000	86807 3.500	24.000
29.01-35.0	28.000	32.000	178.000	108.000	60.000	5.000	86807 3.500	28.000
35.01-45.0	34.000	32.000	223.000	152.000	60.000	7.000	86807 4.001	34.000
45.01-55.0	44.000	40.000	233.000	152.000	70.000	7.000	86807 4.001	44.000
55.01-65.0	54.000	40.000	233.000	152.000	70.000	7.000	86807 4.001	54.000



Multiplex holder with straight shank

Article no. 86622



nickel-plated • Holder for interchangeable inserts. The straight shank holder possesses internal coolant supply. Wide flutes ensure optimal chip evacuation. Simple replacement of inserts via clamping screws. Adjustment of interchangeable inserts not necessary. The interchangeable inserted drill machines solid material. This drill is not suitable for drilling pre-cast or pre-drilled holes. Clamping screws art.-no. 86807 included.

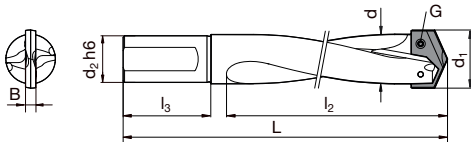

d1 mm	d mm	d2 mm	L mm	l2 mm	l3 mm	B mm	G	Code no.
10.00-11.7	9.500	20.000	140.000	83.000	40.000	2.500	86807 2.000	9.500
11.71-13.4	11.500	20.000	150.000	94.000	40.000	2.500	86807 2.000	11.500
13.41-16.4	13.000	20.000	160.000	104.000	40.000	3.500	86807 2.500	13.000
16.41-18.9	16.000	20.000	170.000	117.000	40.000	3.500	86807 2.501	16.000
18.91-22.4	18.500	20.000	180.000	129.000	40.000	4.000	86807 3.000	18.500
22.41-25.4	22.000	20.000	180.000	131.000	40.000	4.000	86807 3.001	22.000
25.41-29.0	24.000	32.000	240.000	166.000	60.000	5.000	86807 3.500	24.000
29.01-35.0	28.000	32.000	240.000	170.000	60.000	5.000	86807 3.500	28.000
35.01-45.0	34.000	32.000	280.000	210.000	60.000	7.000	86807 4.001	34.000
45.01-55.0	44.000	40.000	290.000	210.000	70.000	7.000	86807 4.001	44.000
55.01-65.0	54.000	40.000	290.000	210.000	70.000	7.000	86807 4.001	54.000



Multiplex holder with straight shank

Article no. 86624



nickel-plated • Holder for interchangeable inserts. The straight shank holder possesses internal coolant supply. Wide flutes ensure optimal chip evacuation. Simple replacement of inserts via clamping screws. Adjustment of interchangeable inserts not necessary. The interchangeable inserted drill machines solid material. This drill is not suitable for drilling pre-cast or pre-drilled holes. Clamping screws art.-no. 86807 included.

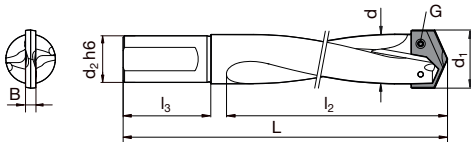

d1 mm	d mm	d2 mm	L mm	l2 mm	l3 mm	B mm	G	Code no.
10.00-11.7	9.500	20.000	180.000	123.000	40.000	2.500	86807 2.000	9.500
11.71-13.4	11.500	20.000	190.000	134.000	40.000	2.500	86807 2.000	11.500
13.41-16.4	13.000	20.000	210.000	155.000	40.000	3.500	86807 2.500	13.000
16.41-18.9	16.000	20.000	220.000	168.000	40.000	3.500	86807 2.501	16.000
18.91-22.4	18.500	20.000	250.000	199.000	40.000	4.000	86807 3.000	18.500
22.41-25.4	22.000	20.000	250.000	201.000	40.000	4.000	86807 3.001	22.000
25.41-29.0	24.000	32.000	320.000	246.000	60.000	5.000	86807 3.500	24.000
29.01-35.0	28.000	32.000	320.000	250.000	60.000	5.000	86807 3.500	28.000
35.01-45.0	34.000	32.000	380.000	310.000	60.000	7.000	86807 4.001	34.000
45.01-55.0	44.000	40.000	390.000	310.000	70.000	7.000	86807 4.001	44.000
55.01-65.0	54.000	40.000	390.000	310.000	70.000	7.000	86807 4.001	54.000



Multiplex holder with straight shank

Article no. 86628



nickel-plated • Holder for interchangeable inserts. The extra length holder with straight shank possesses an internal coolant supply. Wide flutes ensure optimal chip evacuation. Simple replacement of inserts via clamping screws. Adjustment of interchangeable inserts not necessary. The interchangeable inserted drill machines solid material. This drill is not suitable for drilling pre-cast or pre-drilled holes. Clamping screws art.-no. 86807 included

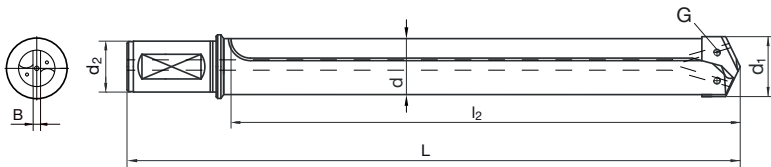

d1 mm	d mm	d2 mm	L mm	l2 mm	B mm	G	Code no.
13.41-16.4	13.000	20.000	198.500	156.500	3.500	86807 2.500	13.157
13.41-16.4	13.000	20.000	238.500	196.500	3.500	86807 2.500	13.197
13.41-16.4	13.000	20.000	318.500	276.500	3.500	86807 2.500	13.277
15.00-16.4	14.500	20.000	95.000	52.000	3.500	86807 2.500	14.052
15.00-16.4	14.500	20.000	125.000	82.000	3.500	86807 2.500	14.082
15.00-16.4	14.500	20.000	178.500	136.500	3.500	86807 2.500	14.137
15.00-16.4	14.500	20.000	198.500	156.500	3.500	86807 2.500	14.157
15.00-16.4	14.500	20.000	238.500	196.500	3.500	86807 2.500	14.197
15.00-16.4	14.500	20.000	268.500	226.500	3.500	86807 2.500	14.227
15.00-16.4	14.500	20.000	398.500	356.500	3.500	86807 2.500	14.357
16.41-18.9	16.000	20.000	260.500	218.500	3.500	86807 2.500	16.219
16.41-18.9	16.000	20.000	295.500	253.500	3.500	86807 2.500	16.254
16.41-18.9	16.000	20.000	410.500	368.500	3.500	86807 2.501	16.369
18.91-22.4	18.500	20.000	304.000	262.000	4.000	86807 3.000	18.262
18.91-22.4	18.500	20.000	344.000	302.000	4.000	86807 3.000	18.302
18.91-22.4	18.500	20.000	464.000	422.000	4.000	86807 3.000	18.422
22.41-25.4	22.000	20.000	285.000	243.000	4.000	86807 3.001	22.243
22.41-25.4	22.000	20.000	345.000	303.000	4.000	86807 3.001	22.303
22.41-25.4	22.000	20.000	385.000	343.000	4.000	86807 3.001	22.343
22.41-25.4	22.000	20.000	535.000	493.000	4.000	86807 3.001	22.493
25.41-29.0	23.000	32.000	138.000	63.000	5.000	86807 3.500	23.063
25.41-29.0	23.000	32.000	173.000	98.000	5.000	86807 3.500	23.098
25.41-29.0	23.000	32.000	225.000	150.000	5.000	86807 3.500	23.150
25.41-29.0	23.000	32.000	273.000	198.000	5.000	86807 3.500	23.198
25.41-29.0	23.000	32.000	343.000	268.000	5.000	86807 3.500	23.268
25.41-29.0	23.000	32.000	433.000	358.000	5.000	86807 3.500	23.358
25.41-29.0	23.000	32.000	503.000	428.000	5.000	86807 3.500	23.428
25.41-29.0	23.000	32.000	683.000	608.000	5.000	86807 3.500	23.608
29.01-35.0	28.000	32.000	393.000	321.500	5.000	86807 3.500	28.322
29.01-35.0	28.000	32.000	473.000	401.500	5.000	86807 3.500	28.402
29.01-35.0	28.000	32.000	553.000	481.500	5.000	86807 3.500	28.482
29.01-35.0	28.000	32.000	763.000	691.500	5.000	86807 3.500	28.692
33.20-36.0	33.000	32.000	148.000	80.500	5.000	86807 3.500	33.081
33.20-36.0	33.000	32.000	173.000	105.500	5.000	86807 3.500	33.106
33.20-36.0	33.000	32.000	223.000	155.500	5.000	86807 3.500	33.156
33.20-36.0	33.000	32.000	273.000	205.500	5.000	86807 3.500	33.206
33.20-36.0	33.000	32.000	393.000	325.500	5.000	86807 3.500	33.326
33.20-36.0	33.000	32.000	503.000	435.500	5.000	86807 3.500	33.436
33.20-36.0	33.000	32.000	603.000	535.500	5.000	86807 3.500	33.536
33.20-36.0	33.000	32.000	823.000	755.500	5.000	86807 3.500	33.756
35.01-45.0	34.000	32.000	457.000	388.000	7.000	86807 4.001	34.388
35.01-45.0	34.000	32.000	607.000	538.000	7.000	86807 4.001	34.538



Multiplex holder with straight shank

d1 mm	d mm	d2 mm	L mm	l2 mm	B mm	G	Code no.
35.01-45.0	34.000	32.000	907.000	838.000	7.000	86807 4.001	34.838
45.01-55.0	44.000	40.000	467.000	394.000	7.000	86807 4.001	44.394
45.01-55.0	44.000	40.000	617.000	544.000	7.000	86807 4.001	44.544
45.01-55.0	44.000	40.000	917.000	844.000	7.000	86807 4.001	44.844
55.01-65.0	54.000	40.000	467.000	393.000	7.000	86807 4.001	54.393
55.01-65.0	54.000	40.000	617.000	543.000	7.000	86807 4.001	54.543
55.01-65.0	54.000	40.000	917.000	843.000	7.000	86807 4.001	54.843
65.01-78.0	63.000	40.000	230.000	155.000	9.000	86807 5.000	63.155
65.01-78.0	63.000	40.000	340.000	265.000	9.000	86807 5.000	63.265
65.01-78.0	63.000	40.000	470.000	395.000	9.000	86807 5.000	63.395
65.01-78.0	63.000	40.000	620.000	545.000	9.000	86807 5.000	63.545
65.01-78.0	63.000	40.000	920.000	845.000	9.000	86807 5.000	63.845
78.01-90.0	77.000	50.000	240.000	155.000	9.000	86807 5.000	77.155
78.01-90.0	77.000	50.000	350.000	265.000	9.000	86807 5.000	77.265
78.01-90.0	77.000	50.000	480.000	395.000	9.000	86807 5.000	77.395
78.01-90.0	77.000	50.000	630.000	545.000	9.000	86807 5.000	77.545
78.01-90.0	77.000	50.000	930.000	845.000	9.000	86807 5.000	77.845
90.01-102.0	89.000	50.000	240.000	155.000	9.000	86807 5.000	89.155
90.01-102.0	89.000	50.000	350.000	265.000	9.000	86807 5.000	89.265
90.01-102.0	89.000	50.000	480.000	395.000	9.000	86807 5.000	89.395
90.01-102.0	89.000	50.000	630.000	545.000	9.000	86807 5.000	89.545
90.01-102.0	89.000	50.000	930.000	845.000	9.000	86807 5.000	89.845

MULTIPLYER HOLDER WITH MORSE TAPER SHANK





Multiplex holder with morse taper shank

Article no. 86630



nickel-plated • Short design holder for interchangeable inserts. The taper shank holder possesses internal coolant supply. Wide flutes ensure optimal chip evacuation. Simple replacement of inserts via clamping screws. Adjustment of interchangeable inserts not necessary. The interchangeable inserted drill machines solid material. This drill is not suitable for drilling pre-cast or pre-drilled holes. Coolant supply: axial (radial on request) Clamping screws art.-no. 86807 included

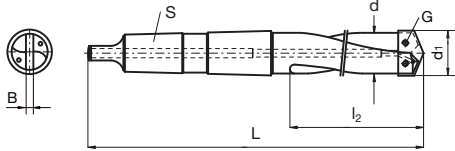

d1 mm	d mm	S	L mm	l ₂ mm	B mm	G	Code no.
10.00-11.7	9.500	MK-2	139.000	56.000	2.500	86807 2.000	9.500
11.71-13.4	11.500	MK-2	141.000	58.000	2.500	86807 2.000	11.500
13.41-16.4	13.000	MK-2	148.000	63.000	3.500	86807 2.500	13.000
16.41-18.9	16.000	MK-2	150.000	67.000	3.500	86807 2.501	16.000
18.91-22.4	18.500	MK-3	178.000	76.000	4.000	86807 3.000	18.500
22.41-25.4	22.000	MK-3	181.000	80.000	4.000	86807 3.001	22.000



Multiplex holder with morse taper shank

Article no. 86650



nickel-plated • Long design holder for interchangeable inserts. The taper shank holder possesses internal coolant supply. Wide flutes ensure optimal chip evacuation. Simple replacement of inserts via clamping screws. Adjustment of interchangeable inserts not necessary. The interchangeable inserted drill machines solid material. This drill is not suitable for drilling pre-cast or pre-drilled holes.
Coolant supply: axial (radial on request)
Clamping screws art.-no. 86807 included

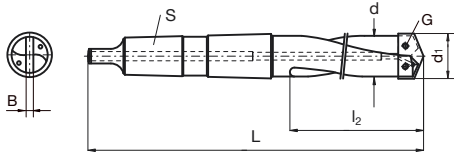

d1 mm	d mm	S	L mm	l ₂ mm	B mm	G	Code no.
10.00-11.7	9.500	MK-2	186.000	103.000	2.500	86807 2.000	9.500
11.71-13.4	11.500	MK-2	191.000	108.000	2.500	86807 2.000	11.500
13.41-16.4	13.000	MK-2	210.000	125.000	3.500	86807 2.500	13.000
16.41-18.9	16.000	MK-2	218.000	135.000	3.500	86807 2.501	16.000
18.91-22.4	18.500	MK-3	258.000	156.000	4.000	86807 3.000	18.500
22.41-25.4	22.000	MK-3	266.000	166.000	4.000	86807 3.001	22.000



Multiplex holder with morse taper shank

Article no. 86670



≤ Ø 28 mm: nickel-plated, > Ø 28 mm: burnished • Short design holder for interchangeable inserts with ring face for coolant supply ring. The taper shank holder possesses internal coolant supply. Wide flutes ensure optimal chip evacuation. Simple replacement of inserts via clamping screws. Adjustment of interchangeable inserts not necessary. The interchangeable inserted drill machines solid material. This drill is not suitable for drilling pre-cast or pre-drilled holes.

Coolant supply: radial (axial on request)

From holder-Ø 63.0 mm: straight-fluted

Shank size MK 5: with cross-key slot

Clamping screws art.-no. 86807 included

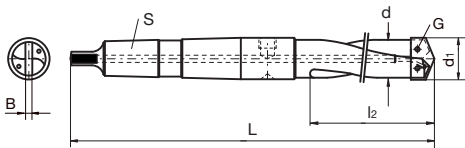

d1 mm	d mm	S	L mm	l2 mm	B mm	G	Code no.
25.01-29.0	24.000	MK-4	279.000	108.000	5.000	86807 3.500	24.000
29.01-35.0	28.000	MK-4	279.000	108.000	5.000	86807 3.500	28.000
35.01-45.0	34.000	MK-4	324.000	152.000	7.000	86807 4.001	34.000
45.01-55.0	44.000	MK-4	324.000	152.000	7.000	86807 4.001	44.000
55.01-65.0	54.000	MK-4	324.000	152.000	7.000	86807 4.001	54.000
65.01-78.0	63.000	MK-5	436.000	216.000	9.000	86807 5.000	63.000
78.01-90.0	77.000	MK-5	436.000	216.000	9.000	86807 5.000	77.000
90.01-102.0	89.000	MK-5	436.000	216.000	9.000	86807 5.000	89.000



Multiplex holder with morse taper shank

Article no. 86680



≤ Ø 28 mm: nickel-plated, > Ø 28 mm: burnished • Long design holder for interchangeable inserts with ring face for coolant supply ring. The taper shank holder possesses internal coolant supply. Wide flutes ensure optimal chip evacuation. Simple replacement of inserts via clamping screws. Adjustment of interchangeable inserts not necessary. The interchangeable inserted drill machines solid material. This drill is not suitable for drilling pre-cast or pre-drilled holes.

Coolant supply: radial (axial on request)

From holder-Ø 63.0 mm: straight-fluted

Shank size MK 5: with cross-key slot

Clamping screws art.-no. 86807 included

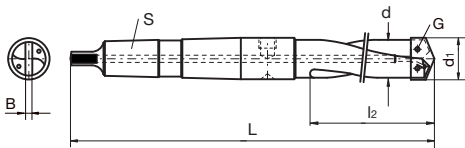

d1 mm	d mm	S	L mm	l2 mm	B mm	G	Code no.
25.01-29.0	24.000	MK-4	379.000	208.000	5.000	86807 3.500	24.000
29.01-35.0	28.000	MK-4	379.000	208.000	5.000	86807 3.500	28.000
35.01-45.0	34.000	MK-4	429.000	257.000	7.000	86807 4.001	34.000
45.01-55.0	44.000	MK-4	429.000	257.000	7.000	86807 4.001	44.000
55.01-65.0	54.000	MK-4	429.000	257.000	7.000	86807 4.001	54.000
65.01-78.0	63.000	MK-5	536.000	316.000	9.000	86807 5.000	63.000
78.01-90.0	77.000	MK-5	536.000	316.000	9.000	86807 5.000	77.000
90.01-102.0	89.000	MK-5	536.000	316.000	9.000	86807 5.000	89.000



Multiplex holder with morse taper shank

Article no. 86678



surface nickel-plated ≤ 1000 mm total length, > 1000 mm overall length: burnished • Extra length design holder for interchangeable inserts. The taper shank holder possesses internal coolant supply. Wide flutes ensure optimal chip evacuation. Simple replacement of inserts via clamping screws. Adjustment of interchangeable inserts not necessary. The interchangeable inserted drill machines solid material. This drill is not suitable for drilling pre-cast or pre-drilled holes.

Coolant supply: radial (axial on request)
Clamping screws art.-no. 86807 included



d1 mm	d mm	S	L mm	l2 mm	B mm	G	Code no.
35.01-45.0	34.000	MK-4	566.000	393.000	7.000	86807 4.001	34.393
35.01-45.0	34.000	MK-4	716.000	543.000	7.000	86807 4.001	34.543
35.01-45.0	34.000	MK-4	1016.000	843.000	7.000	86807 4.001	34.843
45.01-55.0	44.000	MK-4	716.000	544.500	7.000	86807 4.001	44.545
45.01-55.0	44.000	MK-4	1016.000	844.500	7.000	86807 4.001	44.845
55.01-65.0	54.000	MK-4	560.000	387.000	7.000	86807 4.001	54.387
55.01-65.0	54.000	MK-4	716.000	543.000	7.000	86807 4.001	54.543
55.01-65.0	54.000	MK-4	1016.000	843.000	7.000	86807 4.001	54.843
65.01-78.0	63.000	MK-5	766.000	547.000	9.000	86807 5.000	63.547
65.01-78.0	63.000	MK-5	1066.000	847.000	9.000	86807 5.000	63.847
78.01-90.0	77.000	MK-5	766.000	544.000	9.000	86807 5.000	77.544
78.01-90.0	77.000	MK-5	1066.000	844.000	9.000	86807 5.000	77.844
90.01-102.0	89.000	MK-5	766.000	544.000	9.000	86807 5.000	89.544
90.01-102.0	89.000	MK-5	1066.000	844.000	9.000	86807 5.000	89.844



Special range Multiplex modular system Ø 97 mm to 210 mm



HOLDERS

The following versions are available on request:

- ISO taper 50 DIN ISO 7388-1 with oil feed adaptors

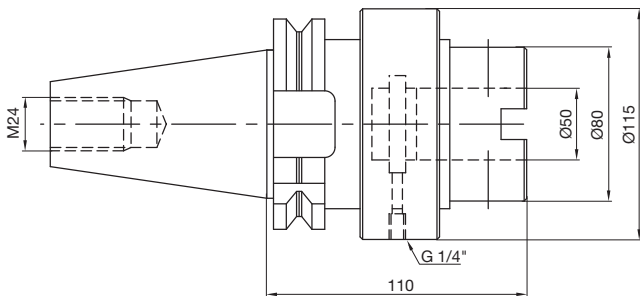

- ISO taper 50 DIN ISO 7388-1 without oil feed adaptors

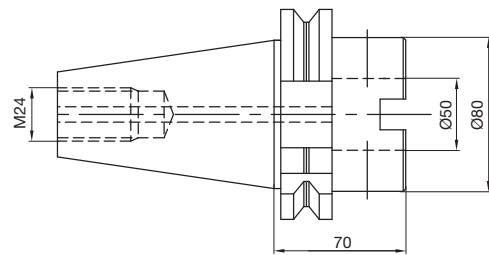

- ISO taper 50 DIN 2080 with oil feed adaptors

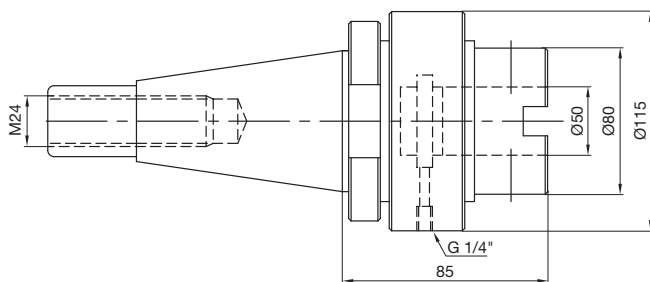

- ISO taper 50 DIN 2080 without oil feed adaptors

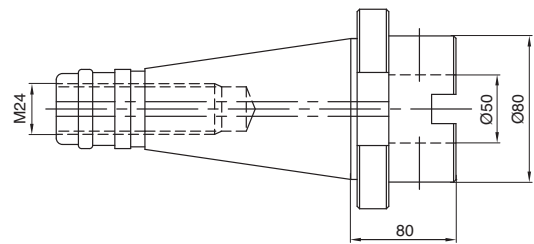

- MK 5/MK 6 with oil feed adaptors

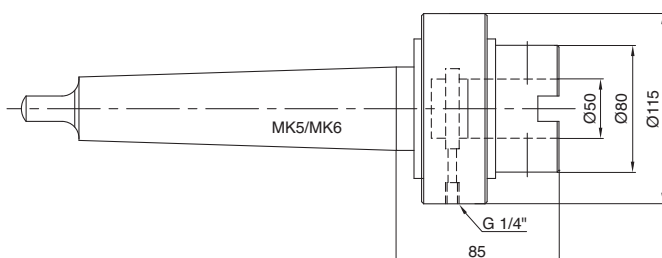

- MK 5/MK 6 without oil feed adaptors

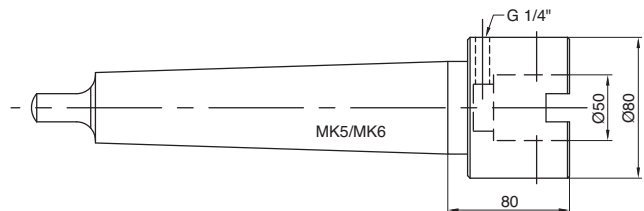



Special range Multiplex modular system Ø 97 mm to 210 mm

Extensions for drill heads



Extensions for drill heads
 Ø 97 mm - Ø 130 mm*
 L = 186 mm
 L = 300 mm

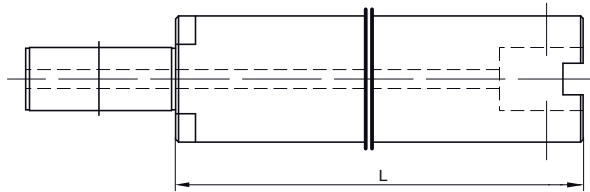

Extensions for drill heads
 Ø 131 mm - Ø 165 mm and Ø 164 mm - Ø 210 mm
 L = 204 mm
 L = 300 mm
 L = 500 mm

Tangs



small, for drill heads Ø 97 mm - Ø 130 mm,
 width 14 mm



large, for drill heads Ø 131 mm - Ø 165 mm
 and Ø 164 mm - Ø 210 mm, width 16 mm

Drill heads

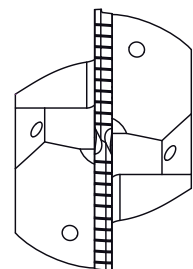
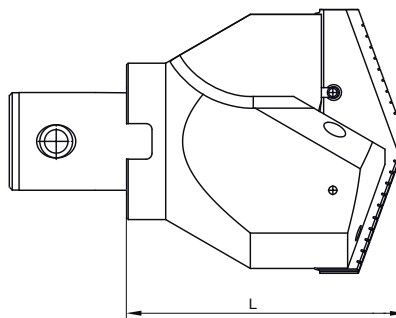
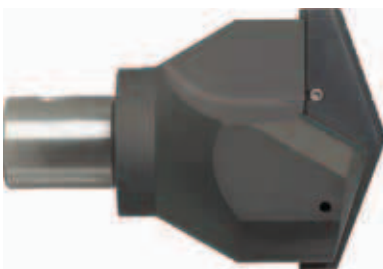

The following versions are available on request:

- Ø 97 mm to Ø 130 mm, L = 118.5 mm*
- Ø 131 mm to Ø 165 mm, L = 142.5 mm
- Ø 164 mm to Ø 210 mm, L = 142.5 mm

* Reduction unit required



Interchangeable inserts

Article no. 86602



P	M	K	N	S	H
●	○	●	○		



web thinning ≥ Ø 9.800 • Interchangeable insert with chip breakers. 135° point angle. For universal application.

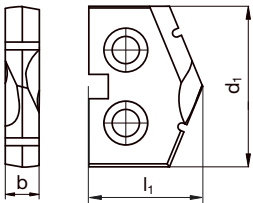

d1 mm	l1 mm	b mm	Code no.	d1 mm	l1 mm	b mm	Code no.
10.000	8.700	2.500	10.000	18.000	11.700	3.500	18.000
10.200	8.700	2.500	10.200	18.250	11.700	3.500	18.250
10.500	8.700	2.500	10.500	18.500	11.700	3.500	18.500
11.000	8.700	2.500	11.000	18.750	11.700	3.500	18.750
11.110	8.700	2.500	11.110	19.000	13.700	4.000	19.000
11.500	8.700	2.500	11.500	19.500	13.700	4.000	19.500
11.750	8.700	2.500	11.750	19.750	13.700	4.000	19.750
12.000	8.700	2.500	12.000	20.000	13.700	4.000	20.000
12.300	8.700	2.500	12.300	20.250	13.700	4.000	20.250
12.500	8.700	2.500	12.500	20.500	13.700	4.000	20.500
12.750	8.700	2.500	12.750	21.000	13.700	4.000	21.000
13.000	8.700	2.500	13.000	21.250	13.700	4.000	21.250
13.250	8.700	2.500	13.250	21.500	13.700	4.000	21.500
13.500	11.700	3.500	13.500	21.750	13.700	4.000	21.750
13.750	11.700	3.500	13.750	22.000	13.700	4.000	22.000
14.000	11.700	3.500	14.000	22.500	13.700	4.000	22.500
14.250	11.700	3.500	14.250	23.000	13.700	4.000	23.000
14.500	11.700	3.500	14.500	23.500	13.700	4.000	23.500
14.750	11.700	3.500	14.750	24.000	13.700	4.000	24.000
15.000	11.700	3.500	15.000	24.500	13.700	4.000	24.500
15.250	11.700	3.500	15.250	24.750	13.700	4.000	24.750
15.500	11.700	3.500	15.500	25.000	13.700	4.000	25.000
15.750	11.700	3.500	15.750				
16.000	11.700	3.500	16.000				
16.500	11.700	3.500	16.500				
16.750	11.700	3.500	16.750				
17.000	11.700	3.500	17.000				
17.250	11.700	3.500	17.250				
17.500	11.700	3.500	17.500				
17.750	11.700	3.500	17.750				



Interchangeable inserts

Article no. 86605



P	M	K	N	S	H
○	●	○	●	●	



web thinning $\geq \varnothing 25.000$ • Interchangeable insert with chip breakers. INOX geometry for stainless steel, aluminium alloys and non-ferrous metals.

Point angle:

$\geq \varnothing 25.0$ mm = 132°

$> \varnothing 66.0$ mm = 140°

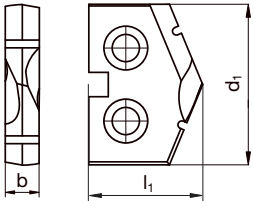

d1 mm	l1 mm	b mm	Code no.	d1 mm	l1 mm	b mm	Code no.
25.000	17.300	5.000	25.000	56.000	24.000	7.000	56.000
25.500	17.300	5.000	25.500	57.000	24.000	7.000	57.000
26.000	17.300	5.000	26.000	58.000	24.000	7.000	58.000
26.500	17.300	5.000	26.500	59.000	24.000	7.000	59.000
27.000	17.300	5.000	27.000	60.000	24.000	7.000	60.000
28.000	17.300	5.000	28.000	62.000	24.000	7.000	62.000
29.000	17.300	5.000	29.000	64.000	24.000	7.000	64.000
29.500	17.300	5.000	29.500	65.000	24.000	7.000	65.000
30.000	17.300	5.000	30.000	66.000	37.000	9.000	66.000
31.000	17.300	5.000	31.000	68.000	37.000	9.000	68.000
32.000	17.300	5.000	32.000	70.000	37.000	9.000	70.000
33.000	17.300	5.000	33.000	74.000	37.000	9.000	74.000
34.000	17.300	5.000	34.000	75.000	37.000	9.000	75.000
35.000	17.300	5.000	35.000	78.000	37.000	9.000	78.000
36.000	24.000	7.000	36.000	80.000	37.000	9.000	80.000
37.000	24.000	7.000	37.000	82.000	37.000	9.000	82.000
37.500	24.000	7.000	37.500	84.000	37.000	9.000	84.000
38.000	24.000	7.000	38.000	85.000	37.000	9.000	85.000
39.000	24.000	7.000	39.000	88.000	37.000	9.000	88.000
40.000	24.000	7.000	40.000	90.000	37.000	9.000	90.000
41.000	24.000	7.000	41.000	94.000	37.000	9.000	94.000
42.000	24.000	7.000	42.000	95.000	37.000	9.000	95.000
43.000	24.000	7.000	43.000	96.000	37.000	9.000	96.000
44.000	24.000	7.000	44.000	98.000	37.000	9.000	98.000
45.000	24.000	7.000	45.000	100.000	37.000	9.000	100.000
46.000	24.000	7.000	46.000	102.000	37.000	9.000	102.000
47.000	24.000	7.000	47.000				
48.000	24.000	7.000	48.000				
49.000	24.000	7.000	49.000				
50.000	24.000	7.000	50.000				
50.500	24.000	7.000	50.500				
51.000	24.000	7.000	51.000				
52.000	24.000	7.000	52.000				
53.000	24.000	7.000	53.000				
54.000	24.000	7.000	54.000				
55.000	24.000	7.000	55.000				



Interchangeable inserts

Article no. 86608



P	M	K	N	S	H
•	○	•	○		

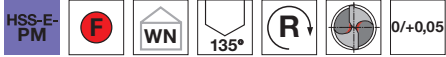

web thinning ≥ Ø 10.000 • Interchangeable insert with chip breakers. 135° point angle. For universal application.

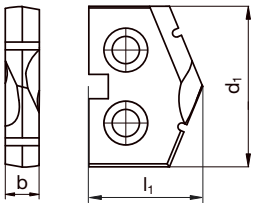

d1 mm	l1 mm	b mm	Code no.	d1 mm	l1 mm	b mm	Code no.
10.000	8.700	2.500	10.000	17.750	11.700	3.500	17.750
10.500	8.700	2.500	10.500	18.000	11.700	3.500	18.000
11.000	8.700	2.500	11.000	18.250	11.700	3.500	18.250
11.500	8.700	2.500	11.500	18.500	11.700	3.500	18.500
11.750	8.700	2.500	11.750	18.750	11.700	3.500	18.750
12.000	8.700	2.500	12.000	19.000	13.700	4.000	19.000
12.500	8.700	2.500	12.500	19.500	13.700	4.000	19.500
12.750	8.700	2.500	12.750	19.750	13.700	4.000	19.750
13.000	8.700	2.500	13.000	20.000	13.700	4.000	20.000
13.250	8.700	2.500	13.250	20.250	13.700	4.000	20.250
13.500	11.700	3.500	13.500	20.500	13.700	4.000	20.500
13.750	11.700	3.500	13.750	21.000	13.700	4.000	21.000
14.000	11.700	3.500	14.000	21.250	13.700	4.000	21.250
14.250	11.700	3.500	14.250	21.500	13.700	4.000	21.500
14.500	11.700	3.500	14.500	21.750	13.700	4.000	21.750
14.750	11.700	3.500	14.750	22.000	13.700	4.000	22.000
15.000	11.700	3.500	15.000	22.500	13.700	4.000	22.500
15.250	11.700	3.500	15.250	23.000	13.700	4.000	23.000
15.500	11.700	3.500	15.500	23.500	13.700	4.000	23.500
15.750	11.700	3.500	15.750	24.000	13.700	4.000	24.000
16.000	11.700	3.500	16.000	24.500	13.700	4.000	24.500
16.500	11.700	3.500	16.500	24.750	13.700	4.000	24.750
17.000	11.700	3.500	17.000	25.000	13.700	4.000	25.000
17.500	11.700	3.500	17.500				



Interchangeable inserts

Article no. 86609



P	M	K	N	S	H
●	○	●	○		

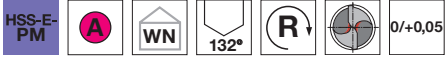

web thinning $\geq \varnothing 25.000$ • Interchangeable insert with chip breakers. For universal application.

Point angle:

- $\geq \varnothing 25.0$ mm = 132°
- $> \varnothing 66.0$ mm = 140°
- $> \varnothing 190.0$ mm = 150°

Tool material:

- $\leq \varnothing 66.0$ mm HSS-E-PM
- $> \varnothing 66.0$ mm HSS-E

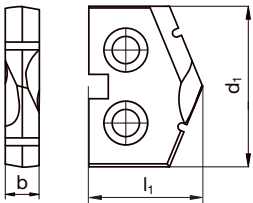

d1 mm	l1 mm	b mm	Code no.	d1 mm	l1 mm	b mm	Code no.
25.000	17.300	5.000	25.000	66.000	37.000	9.000	66.000
25.500	17.300	5.000	25.500	68.000	37.000	9.000	68.000
26.000	17.300	5.000	26.000	70.000	37.000	9.000	70.000
26.500	17.300	5.000	26.500	74.000	37.000	9.000	74.000
27.000	17.300	5.000	27.000	75.000	37.000	9.000	75.000
28.000	17.300	5.000	28.000	78.000	37.000	9.000	78.000
29.000	17.300	5.000	29.000	80.000	37.000	9.000	80.000
29.500	17.300	5.000	29.500	82.000	37.000	9.000	82.000
30.000	17.300	5.000	30.000	84.000	37.000	9.000	84.000
31.000	17.300	5.000	31.000	85.000	37.000	9.000	85.000
32.000	17.300	5.000	32.000	88.000	37.000	9.000	88.000
33.000	17.300	5.000	33.000	90.000	37.000	9.000	90.000
34.000	17.300	5.000	34.000	93.000	37.000	9.000	93.000
35.000	17.300	5.000	35.000	95.000	37.000	9.000	95.000
36.000	24.000	7.000	36.000	96.000	37.000	9.000	96.000
37.000	24.000	7.000	37.000	98.000	37.000	9.000	98.000
38.000	24.000	7.000	38.000	100.000	37.000	9.000	100.000
39.000	24.000	7.000	39.000	102.000	37.000	9.000	102.000
40.000	24.000	7.000	40.000	103.000	37.000	9.000	103.000
41.000	24.000	7.000	41.000	105.000	37.000	9.000	105.000
42.000	24.000	7.000	42.000	110.000	37.000	9.000	110.000
43.000	24.000	7.000	43.000	115.000	37.000	9.000	115.000
44.000	24.000	7.000	44.000	120.000	37.000	9.000	120.000
45.000	24.000	7.000	45.000	125.000	37.000	9.000	125.000
46.000	24.000	7.000	46.000	130.000	37.000	9.000	130.000
47.000	24.000	7.000	47.000	135.000	47.000	9.000	135.000
48.000	24.000	7.000	48.000	140.000	47.000	9.000	140.000
49.000	24.000	7.000	49.000	145.000	47.000	9.000	145.000
50.000	24.000	7.000	50.000	150.000	47.000	9.000	150.000
51.000	24.000	7.000	51.000	155.000	47.000	9.000	155.000
52.000	24.000	7.000	52.000	160.000	47.000	9.000	160.000
53.000	24.000	7.000	53.000	165.000	47.000	9.000	165.000
54.000	24.000	7.000	54.000	170.000	47.000	9.000	170.000
55.000	24.000	7.000	55.000	175.000	47.000	9.000	175.000
56.000	24.000	7.000	56.000	180.000	47.000	9.000	180.000
57.000	24.000	7.000	57.000	185.000	47.000	9.000	185.000
58.000	24.000	7.000	58.000	190.000	47.000	9.000	190.000
59.000	24.000	7.000	59.000	195.000	47.000	9.000	195.000
60.000	24.000	7.000	60.000	200.000	47.000	9.000	200.000
62.000	24.000	7.000	62.000	205.000	47.000	9.000	205.000
64.000	24.000	7.000	64.000	210.000	47.000	9.000	210.000
65.000	24.000	7.000	65.000				



Interchangeable inserts

Article no. 86611

P	M	K	N	S	H
●	○	●	○		

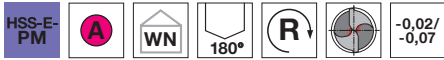

web thinning $\geq \varnothing 10.000$ • Interchangeable insert with chip breakers. For universal application.

Point angle of the centring tip:

$\leq \varnothing 35.0 \text{ mm} = 120^\circ$

$> \varnothing 35.0 \text{ mm} = 140^\circ$

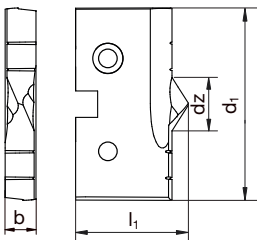

d1 mm	l1 mm	b mm	Code no.	d1 mm	l1 mm	b mm	Code no.
10.000	10.000	2.500	10.000	23.000	15.000	4.000	23.000
10.500	10.000	2.500	10.500	23.500	15.000	4.000	23.500
11.000	10.000	2.500	11.000	24.000	15.000	4.000	24.000
11.500	10.000	2.500	11.500	24.500	15.000	4.000	24.500
11.750	10.000	2.500	11.750	24.750	15.000	4.000	24.750
12.000	10.000	2.500	12.000	25.000	15.000	4.000	25.000
12.500	10.000	2.500	12.500	25.000	18.500	5.000	25.001
12.700	10.000	2.500	12.700	25.400	18.500	5.000	25.400
12.750	10.000	2.500	12.750	25.500	18.500	5.000	25.500
13.000	10.000	2.500	13.000	26.000	18.500	5.000	26.000
13.250	10.000	2.500	13.250	26.500	18.500	5.000	26.500
13.500	13.000	3.500	13.500	27.000	18.500	5.000	27.000
13.750	13.000	3.500	13.750	28.000	18.500	5.000	28.000
14.000	13.000	3.500	14.000	29.000	18.500	5.000	29.000
14.250	13.000	3.500	14.250	29.500	18.500	5.000	29.500
14.500	13.000	3.500	14.500	30.000	18.500	5.000	30.000
14.750	13.000	3.500	14.750	31.000	18.500	5.000	31.000
15.000	13.000	3.500	15.000	32.000	18.500	5.000	32.000
15.250	13.000	3.500	15.250	33.000	18.500	5.000	33.000
15.500	13.000	3.500	15.500	34.000	18.500	5.000	34.000
15.750	13.000	3.500	15.750	35.000	18.500	5.000	35.000
16.000	13.000	3.500	16.000	36.000	25.500	7.000	36.000
16.500	13.000	3.500	16.500	37.000	25.500	7.000	37.000
17.000	13.000	3.500	17.000	38.000	25.500	7.000	38.000
17.500	13.000	3.500	17.500	39.000	25.500	7.000	39.000
17.750	13.000	3.500	17.750	40.000	25.500	7.000	40.000
18.000	13.000	3.500	18.000	41.000	25.500	7.000	41.000
18.250	13.000	3.500	18.250	42.000	25.500	7.000	42.000
18.500	13.000	3.500	18.500	43.000	25.500	7.000	43.000
18.750	13.000	3.500	18.750	44.000	25.500	7.000	44.000
19.000	15.000	4.000	19.000	45.000	25.500	7.000	45.000
19.500	15.000	4.000	19.500	46.000	25.500	7.000	46.000
19.750	15.000	4.000	19.750	47.000	25.500	7.000	47.000
20.000	15.000	4.000	20.000	48.000	25.500	7.000	48.000
20.250	15.000	4.000	20.250	49.000	25.500	7.000	49.000
20.500	15.000	4.000	20.500	50.000	25.500	7.000	50.000
21.000	15.000	4.000	21.000	51.000	25.500	7.000	51.000
21.250	15.000	4.000	21.250	52.000	25.500	7.000	52.000
21.500	15.000	4.000	21.500	53.000	25.500	7.000	53.000
21.750	15.000	4.000	21.750	54.000	25.500	7.000	54.000
22.000	15.000	4.000	22.000	55.000	25.500	7.000	55.000
22.500	15.000	4.000	22.500	56.000	25.500	7.000	56.000



Interchangeable inserts

d1 mm	l1 mm	b mm	Code no.	d1 mm	l1 mm	b mm	Code no.
57.000	25.500	7.000	57.000	65.000	25.500	7.000	65.000
58.000	25.500	7.000	58.000				
59.000	25.500	7.000	59.000				
60.000	25.500	7.000	60.000				
62.000	25.500	7.000	62.000				
64.000	25.500	7.000	64.000				



Interchangeable inserts

Article no. 86701



P	M	K	N	S	H
•	○	•	○		



web thinning $\geq \varnothing 10.000$ • Interchangeable insert without chip breakers. For materials up to 600 N/mm². For universal application.

Point angle:

$\leq \varnothing 25.4 \text{ mm} = 135^\circ$

$> \varnothing 25.4 \text{ mm} = 132^\circ$

Without chamfer (see "Application Recommendations Multiplex"/Technical section)

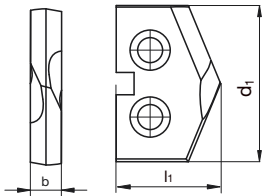

d1 mm	l1 mm	b mm	Code no.	d1 mm	l1 mm	b mm	Code no.
10.000	8.700	2.500	10.000	17.750	11.700	3.500	17.750
10.200	8.700	2.500	10.200	18.000	11.700	3.500	18.000
10.500	8.700	2.500	10.500	18.500	11.700	3.500	18.500
11.000	8.700	2.500	11.000	19.000	13.700	4.000	19.000
11.500	8.700	2.500	11.500	19.500	13.700	4.000	19.500
12.000	8.700	2.500	12.000	20.000	13.700	4.000	20.000
12.500	8.700	2.500	12.500	20.500	13.700	4.000	20.500
12.750	8.700	2.500	12.750	21.000	13.700	4.000	21.000
13.000	8.700	2.500	13.000	21.500	13.700	4.000	21.500
13.500	11.700	3.500	13.500	22.000	13.700	4.000	22.000
13.750	11.700	3.500	13.750	23.000	13.700	4.000	23.000
14.000	11.700	3.500	14.000	24.000	13.700	4.000	24.000
14.250	11.700	3.500	14.250	24.500	13.700	4.000	24.500
14.500	11.700	3.500	14.500	25.000	13.700	4.000	25.000
14.750	11.700	3.500	14.750	26.000	17.300	5.000	26.000
15.000	11.700	3.500	15.000	27.000	17.300	5.000	27.000
15.500	11.700	3.500	15.500	28.000	17.300	5.000	28.000
15.750	11.700	3.500	15.750	29.000	17.300	5.000	29.000
16.000	11.700	3.500	16.000	30.000	17.300	5.000	30.000
16.250	11.700	3.500	16.250	31.000	17.300	5.000	31.000
16.500	11.700	3.500	16.500	32.000	17.300	5.000	32.000
16.750	11.700	3.500	16.750	33.000	17.300	5.000	33.000
17.000	11.700	3.500	17.000	34.000	17.300	5.000	34.000
17.500	11.700	3.500	17.500	35.000	17.300	5.000	35.000



Interchangeable inserts

Article no. 86702



P	M	K	N	S	H
●	○	●	○		



web thinning $\geq \varnothing 10.000$ • Interchangeable insert without chip breaker grooves. For materials above 600 N/mm². For universal application.

point angle:

$\leq \varnothing 25.4 \text{ mm} = 135^\circ$

$> \varnothing 25.4 \text{ mm} = 132^\circ$

with chamfer (see "Application Recommendations Multiplex"/Technical Section)

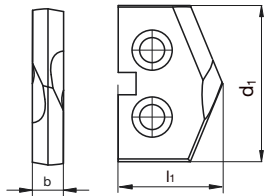

d1 mm	l1 mm	b mm	Code no.	d1 mm	l1 mm	b mm	Code no.
10.000	8.700	2.500	10.000	20.500	13.700	4.000	20.500
10.200	8.700	2.500	10.200	21.000	13.700	4.000	21.000
10.500	8.700	2.500	10.500	21.500	13.700	4.000	21.500
11.000	8.700	2.500	11.000	22.000	13.700	4.000	22.000
12.000	8.700	2.500	12.000	22.300	13.700	4.000	22.300
12.500	8.700	2.500	12.500	22.750	13.700	4.000	22.750
12.750	8.700	2.500	12.750	23.000	13.700	4.000	23.000
13.000	8.700	2.500	13.000	24.250	13.700	4.000	24.250
13.500	11.700	3.500	13.500	24.500	13.700	4.000	24.500
13.750	11.700	3.500	13.750	25.000	13.700	4.000	25.000
14.000	11.700	3.500	14.000	26.000	17.300	5.000	26.000
14.100	11.700	3.500	14.100	26.500	17.300	5.000	26.500
14.500	11.700	3.500	14.500	27.000	17.300	5.000	27.000
14.750	11.700	3.500	14.750	28.000	17.300	5.000	28.000
15.000	11.700	3.500	15.000	29.000	17.300	5.000	29.000
15.500	11.700	3.500	15.500	29.800	17.300	5.000	29.800
16.000	11.700	3.500	16.000	30.000	17.300	5.000	30.000
16.250	11.700	3.500	16.250	32.000	17.300	5.000	32.000
16.500	11.700	3.500	16.500	33.000	17.300	5.000	33.000
16.750	11.700	3.500	16.750	34.000	17.300	5.000	34.000
17.000	11.700	3.500	17.000	35.000	17.300	5.000	35.000
17.500	11.700	3.500	17.500				
17.750	11.700	3.500	17.750				
18.000	11.700	3.500	18.000				
18.250	11.700	3.500	18.250				
18.500	11.700	3.500	18.500				
19.000	13.700	4.000	19.000				
19.500	13.700	4.000	19.500				
19.750	13.700	4.000	19.750				
20.000	13.700	4.000	20.000				



Interchangeable inserts

Article no. 86708



P	M	K	N	S	H
●	○	●	○		



web thinning $\geq \varnothing 9.800$ • Interchangeable insert without chip breaker grooves. For materials above 600 N/mm². For universal application. point angle:

$\leq \varnothing 25.4 \text{ mm} = 135^\circ$

$> \varnothing 25.4 \text{ mm} = 132^\circ$

with chamfer (see "Application Recommendations Multiplex"/Technical Section)

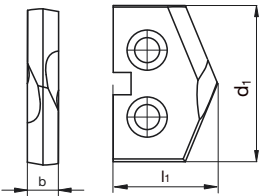

d1 mm	l1 mm	b mm	Code no.	d1 mm	l1 mm	b mm	Code no.
10.000	8.700	2.500	10.000	19.500	13.700	4.000	19.500
10.200	8.700	2.500	10.200	19.750	13.700	4.000	19.750
10.500	8.700	2.500	10.500	20.000	13.700	4.000	20.000
11.000	8.700	2.500	11.000	20.500	13.700	4.000	20.500
11.500	8.700	2.500	11.500	21.000	13.700	4.000	21.000
12.000	8.700	2.500	12.000	21.500	13.700	4.000	21.500
12.250	8.700	2.500	12.250	22.000	13.700	4.000	22.000
12.500	8.700	2.500	12.500	22.500	13.700	4.000	22.500
12.750	8.700	2.500	12.750	22.750	13.700	4.000	22.750
13.000	8.700	2.500	13.000	23.000	13.700	4.000	23.000
13.500	11.700	3.500	13.500	23.500	13.700	4.000	23.500
13.750	11.700	3.500	13.750	24.000	13.700	4.000	24.000
14.000	11.700	3.500	14.000	24.250	13.700	4.000	24.250
14.250	11.700	3.500	14.250	24.500	13.700	4.000	24.500
14.500	11.700	3.500	14.500	25.000	13.700	4.000	25.000
14.750	11.700	3.500	14.750	26.000	17.300	5.000	26.000
15.000	11.700	3.500	15.000	27.000	17.300	5.000	27.000
15.500	11.700	3.500	15.500	28.000	17.300	5.000	28.000
15.750	11.700	3.500	15.750	29.000	17.300	5.000	29.000
16.000	11.700	3.500	16.000	30.000	17.300	5.000	30.000
16.250	11.700	3.500	16.250	31.000	17.300	5.000	31.000
16.500	11.700	3.500	16.500	32.000	17.300	5.000	32.000
16.750	11.700	3.500	16.750	34.000	17.300	5.000	34.000
17.000	11.700	3.500	17.000	35.000	17.300	5.000	35.000
17.500	11.700	3.500	17.500				
17.750	11.700	3.500	17.750				
18.000	11.700	3.500	18.000				
18.250	11.700	3.500	18.250				
18.500	11.700	3.500	18.500				
19.000	13.700	4.000	19.000				



Interchangeable inserts

Article no. 86709



P	M	K	N	S	H
•	○	•	○		

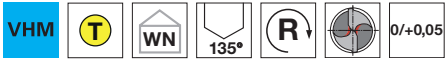

web thinning $\geq \varnothing 9.800$ • Interchangeable insert without chip breakers. For materials up to 600 N/mm². For universal application.

Point angle:

$\leq \varnothing 25.4 \text{ mm} = 135^\circ$

$> \varnothing 25.4 \text{ mm} = 132^\circ$

Without chamfer (see "Application Recommendations Multiplex"/Technical section)

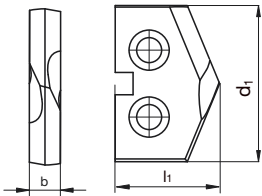

d1 mm	l1 mm	b mm	Code no.	d1 mm	l1 mm	b mm	Code no.
10.000	8.700	2.500	10.000	18.250	11.700	3.500	18.250
10.200	8.700	2.500	10.200	18.500	11.700	3.500	18.500
10.500	8.700	2.500	10.500	19.000	13.700	4.000	19.000
11.000	8.700	2.500	11.000	19.500	13.700	4.000	19.500
11.110	8.700	2.500	11.110	20.000	13.700	4.000	20.000
12.000	8.700	2.500	12.000	20.500	13.700	4.000	20.500
12.500	8.700	2.500	12.500	20.640	13.700	4.000	20.640
12.700	8.700	2.500	12.700	21.000	13.700	4.000	21.000
12.750	8.700	2.500	12.750	21.500	13.700	4.000	21.500
13.000	8.700	2.500	13.000	22.000	13.700	4.000	22.000
13.500	11.700	3.500	13.500	23.000	13.700	4.000	23.000
14.000	11.700	3.500	14.000	23.250	13.700	4.000	23.250
14.500	11.700	3.500	14.500	24.500	13.700	4.000	24.500
14.750	11.700	3.500	14.750	25.000	13.700	4.000	25.000
15.000	11.700	3.500	15.000	26.000	17.300	5.000	26.000
15.880	11.700	3.500	15.880	27.000	17.300	5.000	27.000
16.250	11.700	3.500	16.250	28.000	17.300	5.000	28.000
16.500	11.700	3.500	16.500	29.000	17.300	5.000	29.000
16.670	11.700	3.500	16.670	30.000	17.300	5.000	30.000
16.750	11.700	3.500	16.750	33.000	17.300	5.000	33.000
17.000	11.700	3.500	17.000	34.000	17.300	5.000	34.000
17.500	11.700	3.500	17.500	35.000	17.300	5.000	35.000
17.750	11.700	3.500	17.750				
18.000	11.700	3.500	18.000				



Interchangeable inserts

Article no. 86711



web thinning $\geq \varnothing 10.000$ • Interchangeable insert with chip breakers. Aluminium geometry for .
 aluminium alloys, non-ferrous metals and plastics:
 $\leq \varnothing 25.4 \text{ mm} = 135^\circ$
 $> \varnothing 25.4 \text{ mm} = 132^\circ$

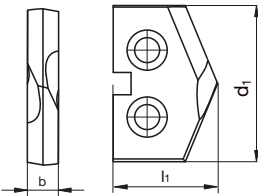

d1 mm	l1 mm	b mm	Code no.	d1 mm	l1 mm	b mm	Code no.
10.000	8.700	2.500	10.000	24.000	13.700	4.000	24.000
10.200	8.700	2.500	10.200	24.250	13.700	4.000	24.250
10.500	8.700	2.500	10.500	24.500	13.700	4.000	24.500
11.000	8.700	2.500	11.000	25.000	13.700	4.000	25.000
11.500	8.700	2.500	11.500	25.400	17.300	5.000	25.400
12.000	8.700	2.500	12.000	26.000	17.300	5.000	26.000
12.250	8.700	2.500	12.250	27.000	17.300	5.000	27.000
12.500	8.700	2.500	12.500	28.000	17.300	5.000	28.000
12.700	8.700	2.500	12.700	29.000	17.300	5.000	29.000
12.750	8.700	2.500	12.750	30.000	17.300	5.000	30.000
13.000	8.700	2.500	13.000	31.000	17.300	5.000	31.000
13.500	11.700	3.500	13.500	32.000	17.300	5.000	32.000
13.750	11.700	3.500	13.750	34.000	17.300	5.000	34.000
14.000	11.700	3.500	14.000	35.000	17.300	5.000	35.000
14.250	11.700	3.500	14.250	36.000	24.000	7.000	36.000
14.500	11.700	3.500	14.500	37.000	24.000	7.000	37.000
14.750	11.700	3.500	14.750	38.000	24.000	7.000	38.000
15.000	11.700	3.500	15.000	39.000	24.000	7.000	39.000
15.500	11.700	3.500	15.500	40.000	24.000	7.000	40.000
15.750	11.700	3.500	15.750	41.000	24.000	7.000	41.000
16.000	11.700	3.500	16.000	42.000	24.000	7.000	42.000
16.250	11.700	3.500	16.250	43.000	24.000	7.000	43.000
16.500	11.700	3.500	16.500	44.000	24.000	7.000	44.000
16.750	11.700	3.500	16.750	45.000	24.000	7.000	45.000
17.000	11.700	3.500	17.000	46.000	24.000	7.000	46.000
17.500	11.700	3.500	17.500	47.000	24.000	7.000	47.000
17.750	11.700	3.500	17.750	48.000	24.000	7.000	48.000
18.000	11.700	3.500	18.000	49.000	24.000	7.000	49.000
18.250	11.700	3.500	18.250	50.000	24.000	7.000	50.000
18.500	11.700	3.500	18.500	51.000	24.000	7.000	51.000
19.000	13.700	4.000	19.000	52.000	24.000	7.000	52.000
19.500	13.700	4.000	19.500	53.000	24.000	7.000	53.000
19.750	13.700	4.000	19.750	54.000	24.000	7.000	54.000
20.000	13.700	4.000	20.000	55.000	24.000	7.000	55.000
20.500	13.700	4.000	20.500	56.000	24.000	7.000	56.000
21.000	13.700	4.000	21.000	57.000	24.000	7.000	57.000
21.500	13.700	4.000	21.500	58.000	24.000	7.000	58.000
22.000	13.700	4.000	22.000	59.000	24.000	7.000	59.000
22.500	13.700	4.000	22.500	60.000	24.000	7.000	60.000
22.750	13.700	4.000	22.750	62.000	24.000	7.000	62.000
23.000	13.700	4.000	23.000	64.000	24.000	7.000	64.000
23.500	13.700	4.000	23.500	65.000	24.000	7.000	65.000

ACCESSORIES





HARTNER

Coolant supply ring

Article no. 86690



Coolant supply ring for holder with Morse Taper and ring face 86670 and 86680 (without screw set).

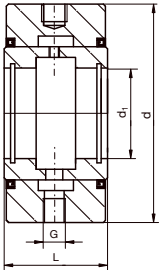

Size	d1 mm	d mm	G	L mm	Code no.
MK 4	31.750	80.000	G1/4	45.000	31.750
MK 5	63.500	127.000	G1/2	60.000	63.500



HARTNER

Coolant supply pipe

Article no. 82571



Coolant supply tube for coolant supply rings art. no. 86690

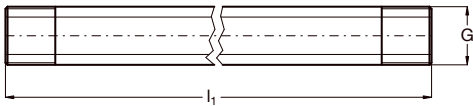

G	l1 mm	Code no.
G1/4	200.000	13.160
G1/2	200.000	20.960



HARTNER

Quick release pipe union

Article no. 82578



quick release pipe union for item no. 82571

G	d3 mm	l1 mm	Code no.
G1/4	9.000	118.000	9.000
G1/2	13.000	118.000	13.000



HARTNER

Torx screwdrivers

Article no. 86842



Screwdriver for Torx screws

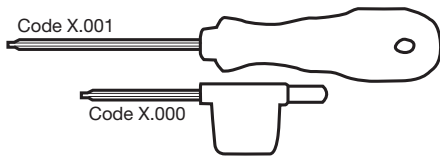

Size	l1 mm	Code no.
T6	150.000	6.001
T7	150.000	7.001
T8	150.000	8.001
T9	150.000	9.001
T10	170.000	10.001
T15	190.000	15.001
T20	205.000	20.001
T25	207.000	25.001



Clamping screws for interchangeable inserts

Article no. 86807



Torx screws for Multiplex holders

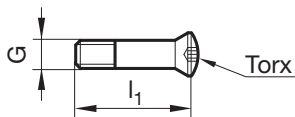

G	l1 mm	Size	Code no.
M2	4.000	T6	2.000
M 2.5	5.000	T7	2.500
M 2.5	7.000	T7	2.501
M 3	6.000	T9	3.000
M 3	8.000	T9	3.001
M 3.5	10.000	T15	3.500
M 4	6.000	T15	4.000
M 4	15.000	T20	4.001
M 5	20.000	T20	5.000



Coolant supply chuck for Multiplex

Article no. 86691



Coolant supply chuck with ISO taper to DIN ISO 7388-1 and cylindrical bore. Application of reducing sleeve with smaller shank-Ø.

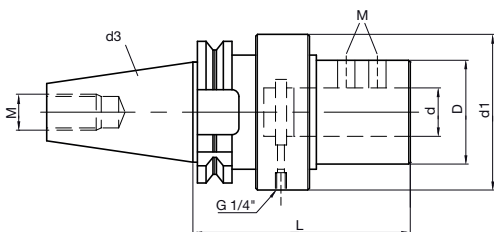

d3	d mm	D mm	d1 mm	L mm	M	Code no.
SK 40	32.000	65.000	88.000	130.000	M16	32.040
SK 50	40.000	65.000	98.000	135.000	M24	40.050
SK 50	50.000	90.000	123.000	165.000	M24	50.050



Coolant supply chuck for Multiplex

Article no. 86692



Coolant supply chuck with ISO taper to DIN 2080 and cylindrical bore. Application of reducing sleeve with smaller shank-Ø.

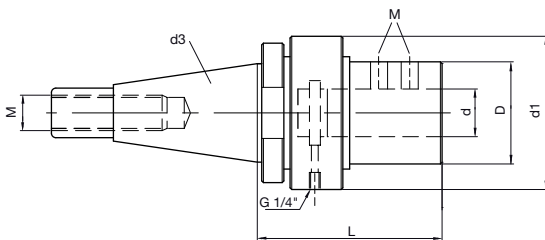

d3	d mm	D mm	d1 mm	L mm	M	Code no.
SK 40	32.000	65.000	88.000	110.000	M16	32.040
SK 50	40.000	65.000	98.000	120.000	M24	40.050
SK 50	50.000	90.000	123.000	145.000	M24	50.050



Coolant supply chuck for Multiplex

Article no. 86693



Coolant supply chuck with Morse Taper to DIN 228 B and cylindrical bore. Application of reducing sleeve with smaller shank-Ø.

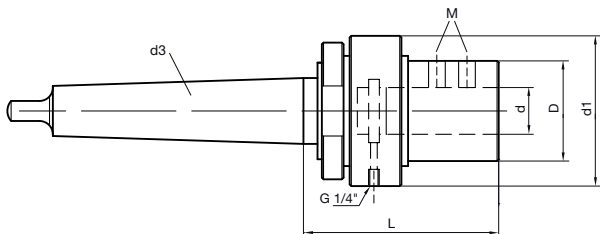

d3	d mm	D mm	d1 mm	L mm	M	Code no.
MK-4	32.000	65.000	88.000	100.000	M14	32.400
MK-5	40.000	75.000	98.000	110.000	M16	40.500
MK-6	40.000	75.000	98.000	120.000	M16	40.600
MK-5	50.000	90.000	123.000	140.000	M20	50.500
MK-6	50.000	90.000	123.000	140.000	M20	50.600



Coolant supply chuck for Multiplex

Article no. 86694



Coolant supply chuck with MAS BT to DIN ISO 7388-2 and cylindrical bore. Application of reducing sleeve with smaller shank-Ø.

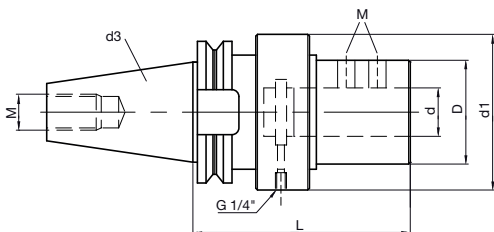

d3	d mm	D mm	d1 mm	L mm	M	Code no.
BT 40	32.000	65.000	88.000	125.000	M16	32.040
BT 50	40.000	65.000	98.000	145.000	M24	40.050
BT 50	50.000	90.000	123.000	170.000	M24	50.050



Reduction bushes for coolant supply chucks

Article no. 86699



Reducing bush for coolant supply chuck with cylindrical internal bore

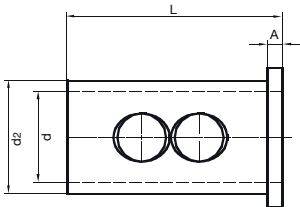

d mm	d2 mm	L mm	A mm	Code no.
20.000	32.000	65.000	5.000	20.032
20.000	40.000	75.000	5.000	20.040
25.000	32.000	65.000	5.000	25.032
25.000	40.000	75.000	5.000	25.040
32.000	40.000	75.000	5.000	32.040

TECHNICAL SECTION





The coolant supply

Every Multiplex holder is equipped with an internal coolant system guaranteeing an optimal supply of the coolant or the lubricant respectively to the cutting edges during horizontal as well as vertical drilling operations and subsequently improving tool life. In addition, the coolant ensures an optimised chip evacuation from the hole. The type of coolant supply is dependent on the shank design:

Coolant supply bore on the end face of the shank

For **static** and **rotary** tools:
Axial coolant supply through the tool holder.
For straight shank holders and hole-Ø 10 to 102 mm.
Holder article no. 86612/86622/86624 and extra length holders.

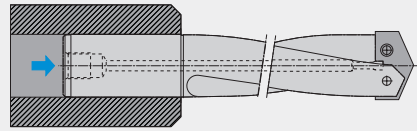

Coolant supply bore on the surface of the shank with supply chuck

For **rotary** tools:
Radial coolant supply through the coolant supply chuck.
For straight shank holders and hole-Ø 10 to 102 mm.
Holder article no. 86612/86622/86624 and extra length holders.
Coolant feed chucks SK40/50 and Morsetaper MK4/5/6 to cyl.

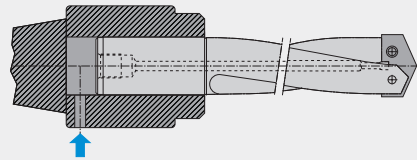

Coolant supply bore in tang

For **static** and **rotary** tools:
Axial coolant supply through the tool holder.
For Morse taper holders and hole-Ø 10 to 25 mm.
Holder article no. 86630/86650.

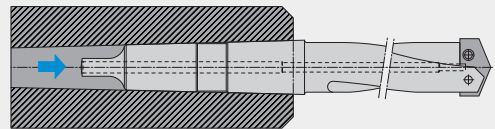

Lateral coolant supply bore on Morse taper

For **static** tools:
Radial coolant supply through the tool holder.
For Morse taper holders and hole-Ø 10 to 25 mm.
Holder on request.

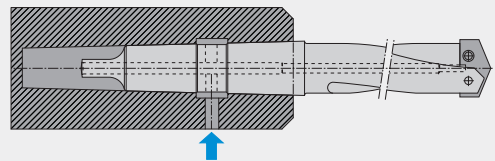

Lateral coolant supply bore at seat of collar position

For **static** tools:
Coolant supply via direct hose/pipe connection with thread R1/4" and R1/2". For Morse taper holders with seat for supply collar for hole-Ø 25 to 102 mm.
Holder article no. 86670/86680 and extra length holders.

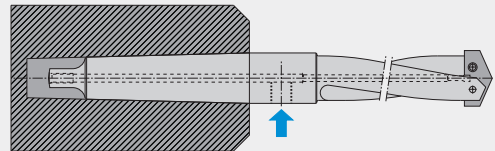

Lateral coolant supply bore at seat of collar position

For **rotary** tools:
Radial coolant supply through the supply collar.
For Morse taper holders with collar running face for hole-Ø over 25 mm.
Holder article no. 86670/86680 and extra length holders.

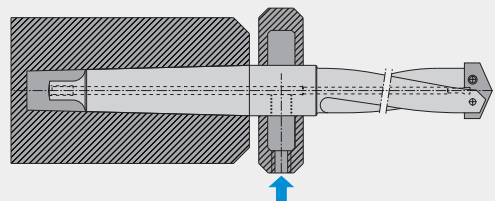



Drilling pre-drilled holes

As Multiplex system is guided predominantly by the chisel edge, it is not suitable for drilling pre-cast or pre-drilled holes. However, if the system is applied under the aforementioned conditions, the cutting parameters should be reduced.

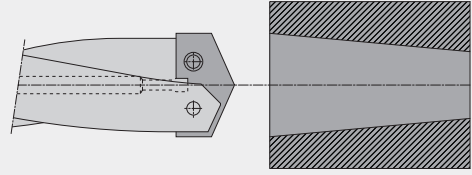

Interrupted cutting

The Multiplex system is not suitable for interrupted cutting (i.e. transverse holes that are larger than the drill diameter).

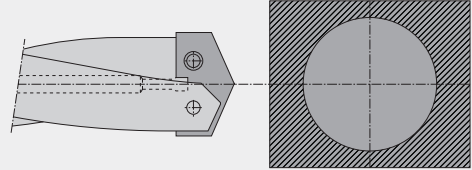

Centering

The inserts for the Multiplex system are web thinned. Therefore, centering is only necessary for larger drilling depths. If centering is necessary for technical reasons, the centering point angle must be equal or larger than the point angle of the insert.

The following applies: up to $d = 25.4 \text{ mm} = 135^\circ$
 up to $d = 66.0 \text{ mm} = 132^\circ$
 from $d = 66.0 \text{ mm} = 140^\circ$

A short holder (3xD) may also be applied for centering.

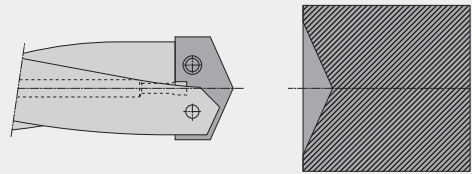

Drill running off center

A drill running off center can be due to several factors. An approximate value of 0.1-0.16 mm for drilling depths up to 7xD is accepted as the norm. In this case the shortest possible and therefore the most rigid holder type should be applied.

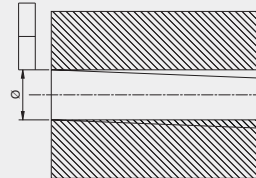

Coolant pressure

The coolant used with the Multiplex system is extremely important for the chip evacuation. It can be delivered at a pressure from approx. 5 bar. Generally, the following rule applies. The more coolant available, the better.

Through the use of coolant collars or coolant supply chucks, the Multiplex system can also be applied on older machines with existing external cooling. One of our technical engineers will gladly find a solution to your specific application task.

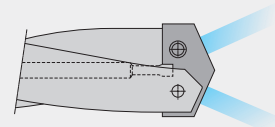

Heavy cutting edge wear

If heat has eroded the corners, the cutting speed is too high and has to be reduced. Measure the unaffected diameter and re-calculate the cutting speed based on this new diameter. Subtract 10% from resulting speed and enter the value into the machine.

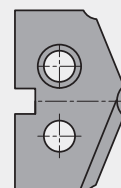



Cooling Agents

An efficient cooling agent is of extreme importance. Insufficient coolant pressure and volume can result in an unsatisfactory surface finish or tool breakage. If possible, the size of solid particles in the coolant should not exceed 50 µm.

For the application of Multiplex tools with high speed steel or carbide inserts we recommend soluble oil as coolant applying the standard ratio of mixture of 1 : 20. The coolant pressure and volume are more important than the composition of the soluble oil. An efficient cooling agent is therefore an important pre-requisite for sufficient cooling and lubrication.

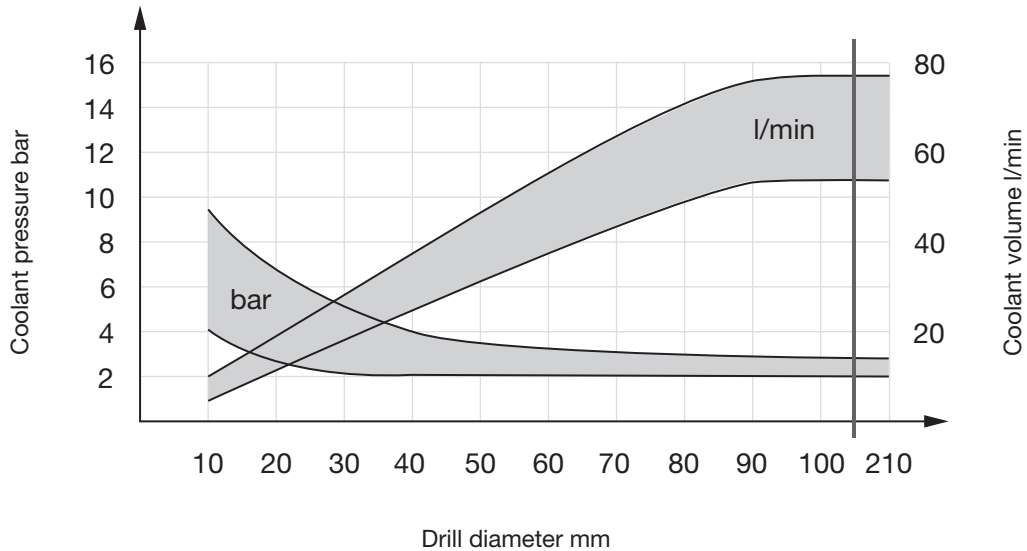

Machine and workpiece

Only a rigid machine, spindle, workpiece and tool clamping make the application of carbide possible. Insufficient rigidity leads to vibrations or rapid corner wear of the drill during the production of through holes when the chisel edge exits the workpiece, resulting in reduced tool life or insert breakage.

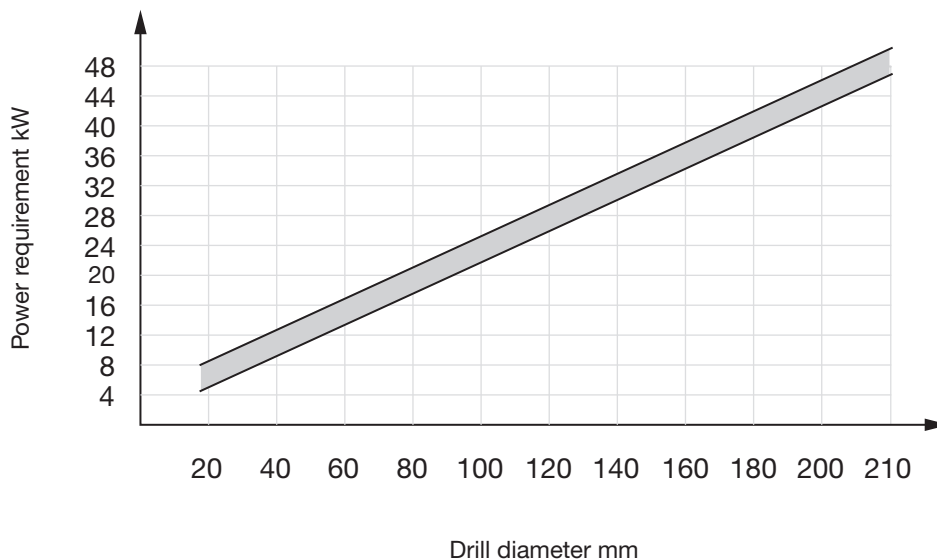



Special geometries



Form insert* to customer's drawing
(HSS-E/PM, HSS-E or Carbide)



NC insert with 90° or 120°
(HSS-E/PM, HSS-E or Carbide)
depending on Ø the 90° angle at the point is distorted



Insert with corner radius
(HSS-E/PM, HSS-E or Carbide)



Stepped insert
(HSS-E/PM, HSS-E or Carbide)



Brass geometry
(Carbide)
for the application in brass and similar materials



Blind hole insert*
(HSS-E/PM or HSS-E)
without center point



Point grind for fiber plastics
(Carbide)



Radius insert*
(HSS-E/PM or HSS-E)

*** Please note when using form or contour inserts:**

- application only with short holders
- pre-machining of bore hole with standard Multiplex insert (\varnothing of standard insert \leq \varnothing of blind hole insert)
- drilling in solid material is recommended only under special conditions
- please forward a drawing of bore hole to our technicians, if possible

Special geometries in combination with different coatings from our programme are available on request.
Please contact us. **Delivery period is approximately 3 weeks.**

Application recommendations Multiplex

Order-Nr.
Ø-range
Tool material
Carbide type
Carbide grade
Surface

Tools with bold feed column no. are preferred choice.

Drill Ø mm	Feed column no.					
	1	2	3	4	5	6
	f (mm/rev.)					
10.00	0.08	0.09	0.11	0.14	0.19	0.24
12.50	0.09	0.11	0.13	0.17	0.22	0.28
16.00	0.11	0.13	0.16	0.21	0.27	0.34
20.00	0.13	0.15	0.19	0.25	0.32	0.40
25.00	0.16	0.18	0.23	0.29	0.38	0.48
31.50	0.19	0.22	0.27	0.35	0.45	0.57
40.00	0.23	0.26	0.33	0.42	0.54	0.69
50.00	0.27	0.31	0.39	0.50	0.64	0.82
63.00	0.32	0.38	0.47	0.60	0.77	0.98
102.00	0.40	0.48	0.59	0.74	0.85	1.20
150.00	0.59	0.70	0.87	1.09	1.25	1.76
100.00	0.78	0.93	1.16	1.45	1.67	2.35

Coolant:

- Air
- Neat oil
- Soluble oil

Material group	Material examples Figures in bold = material no. to DIN EN 10 027	Tensile strength MPa (N/mm ²)	Hardness	Coolant
Common structural steels	1.0035 S185(St33), 1.0486 P275N(StE285), 1.0345 P235GH(H1), 1.0425 P265GH(H2)	≤500		○
	1.0050 E295 (St50-2), 1.0070 E360 (St70-2), 1.8937 P500NH (WStE500)	≤1000		○
Free-cutting steels	1.0718 11SMnPb30 (9SMnPb28), 1.0736 11SMn37 (9SMn36)	≤850		○
	1.0727 46S20 (45S20), 1.0728 (60S20), 1.0757 46SPb20 (45SPb20)	≤1000		○
Unalloyed heat-treatable steels	1.0402 C22, 1.1178 C30E (Ck30)	≤700		○
	1.0503 C45, 1.1191 C45E (Ck45)	≤850		○
	1.0601 C60, 1.1221 C60E (Ck60)	≤1000		○
Alloyed heat-treatable steels	1.5131 50MnSi4, 1.7003 38Cr2, 1.7030 28Cr4	≤1000		○
	1.5710 36NiCr6, 1.7035 41Cr4, 1.7225 42CrMo4	≤1400		○
Unalloyed case hard. steels	1.0301 (C10), 1.1121 C10E (Ck10)	≤850		○
Alloyed case hardened steels	1.7276 10CrMo11, 1.5125 11MnSi6	≤1000		●
	1.5752 15NiCr13, 1.7131 16MnCr5, 1.7264 20CrMo5	≤1400		●
Nitriding steels	1.8504 34CrAl6	≤1000		○
	1.8519 31CrMoV9, 1.8550 34CrAlNi7	≤1400		●
Tool steels	1.1750 C75W, 1.2067 102Cr6, 1.2307 29CrMoV9	≤850		○
	1.2080 X210Cr12, 1.2083 X42Cr13, 1.2419 105WCr6, 1.2767 X45NiCrMo4	≤1400		○
High speed steels	1.3243 S 6-5-2-5, 1.3343 S 6-5-2, 1.3344 S 6-5-3	≤1400		●
Spring steels	1.5026 55Si7, 1.7176 55Cr3, 1.8159 51CrV4 (51CrV4)		≤350 HB	●
Hardened steels	-		≤48 HRC	●
			≤66 HRC	●
Stainless steels, sulphured	1.4005 X12CrS13, 1.4104 X14CrMoS17, 1.4105 X6CrMoS17, 1.4305 X8CrNiS18-9	≤900		●
austenitic	1.4301 X5CrNi18-10 (V2A), 1.4541 X6CrNiTi18-10, 1.4571 X6CrNiMoTi 17-12-2 (V4A)	≤1100		●
martensitic	1.4057 X20CrNi172 (X17CrNi16-2), 1.4122 X39CrMo17-1, 1.4521 X2CrMoTi18-2	≤1500		●
Cast iron	0.6010 EN-GJL-100 (GG10), 0.6020 EN-GJL-200 (GG20)		≤240 HB	○
	0.6025 EN-GJL-250 (GG25), 0.6035 EN-GJL-350 (GG35)		≤350 HB	○
Spheroidal graphite iron and malleable cast iron	0.7050 EN-GJS-500-7 (GGG50), 0.8035 EN-GJMW-350-4 (GTW35)		≤240 HB	○
	0.7070 EN-GJS-700-2 (GGG70), 0.8170 EN-GJMB-700-2 (GTS70)		≤350 HB	○
Chilled cast iron	-		≤350 HB	○
New cast materials GGV	EN-GJV250 (GGV25), EN-GJV350 (GGV35)		≤220 HB	○
	EN-GJV400 (GGV40), EN-GJV500 (GGV50), SiMo 6		≤300 HB	○
New cast materials ADI	EN-GJS-800-8 (ADI800), EN-GJS-1000-5 (ADI1000)	≤1000		○
	EN-GJS-1200-2 (ADI1200), EN-GJS-1400-1 (ADI1400)	≤1400		○
Special alloys	Nimonic, Inconel, Monel, Hastelloy	≤2000		●
Ti and Ti-alloys	3.7024 Ti99,5, 3.7114 TiAl5Sn2,5, 3.7124 TiCu2	≤850		●
	3.7154 TiAl6Zr5, 3.7165 TiAl6V4, 3.7184 TiAl4Mo4Sn2,5, - TiAl8Mo1V1	≤1400		●
Aluminium and Al-alloys	3.0255 Al99,5, 3.2315 AlMgSi1, 3.3515 AlMg1	≤400		○
Al wrought alloys	3.0615 AlMgSiPb, 3.1325 AlCuMg1, 3.3245 AlMg3Si, 3.4365 AlZnMgCu1,5	≤650		○
Al cast alloys ≤ 10 % Si	3.2131 G-AlSi5Cu1, 3.2153 G-AlSi7Cu3, 3.2573 G-AlSi9	≤600		○
≤ 24 % Si	3.2581 G-AlSi12, 3.2583 G-AlSi12Cu, - G-AlSi12CuNiMg	≤600		○
Magnesium alloys	3.5200 MgMn2, 3.5812.05 G-MgAl8Zn1, 3.5612.05 G-MgAl6Zn1	≤400		○
Copper, low-alloyed	2.0070 SE-Cu, 2.1020 CuSn6, 2.1096 G-CuSn5ZnPb	≤500		○
Brass, short-chipping	2.0380 CuZn39Pb2, 2.0401 CuZn39Pb3, 2.0410 CuZn43Pb2	≤600		○
long-chipping	2.0250 CuZn20, 2.0280 CuZn33, 2.0332 CuZn37Pb0,5	≤600		○
Bronze, short-chipping	2.1090 CuSn7ZnPb, 2.1170 CuPb5Sn5, 2.1176 CuPb10Sn	≤600		○
	2.0790 CuNi18Zn19Pb	≤850		○
Bronze, long-chipping	2.0916 CuAl5, 2.0960 CuAl9Mn, 2.1050 CuSn10	≤850		○
	2.0980 CuAl11Ni, 2.1247 CuBe2	≤1000		○
Duroplastics	Bakelit, Resopal, Pertinax, Moltopren	≤150		○
Thermoplastics	Plexiglass, Hostalen, Novodur, Makralon	≤100		○
Kevlar	Kevlar	≤1000		○
Glass, carbon concentr. plastics	GFK/CFK	≤1000		○



HARTNER

86602
10-25
HSS-E-PM



86608
10-25
HSS-E-PM



86605
25-102
HSS-E



86609
10-102
HSS-E-PM



86611
10-65
HSS-E-PM



v_c m/min	Feed column no.	v_c m/min	Feed column no.	v_c m/min	Feed column no.	v_c m/min	Feed column no.	v_c m/min	Feed column no.
40	4	48	4	40	4	48	4	25	3
35	4	42	4	35	4	42	4	25	3
50	5	60	5	50	5	60	5	30	3
40	5	50	5	40	5	50	5	25	3
40	4	45	4	40	4	45	4	22	3
35	4	40	4	35	4	40	4	20	3
30	4	35	4	30	4	35	4	20	3
25	3	28	3	25	3	28	3	15	2
22	2	25	2	22	2	25	2	15	2
35	3	40	3	35	3	40	3	20	2
25	3	28	3	25	3	28	3	15	2
22	2	25	2	22	2	25	2	15	2
22	3	25	3	22	3	25	3	15	2
15	2	18	2	15	2	18	2	12	1
26	3	28	3	26	3	28	3	15	2
22	2	25	2	22	2	25	2	15	2
12	2	18	2	12	2	18	2	10	1
10	2	13	2	10	2	13	2	8	1
20	2	23	2	20	2	23	2	10	1
15	2	17	2	15	2	17	2	10	1
15	2	20	2	15	2	20	2	10	1
35	4	40	4	35	4	40	4	20	3
35	4	40	4	35	4	40	4	20	3
35	4	40	4	35	4	40	4	20	3
28	4	33	4	28	4	33	4	15	3
60	5	65	5	60	5	65	5	32	4
80	5	85	5	80	5	85	5	42	4
85	5	85	5	85	5	85	5	42	4
70	5	70	5	70	5	70	5	35	4
45	4	50	4	45	4	50	4	25	3
45	4	50	4	45	4	50	4	25	3
60	5	65	5	60	5	65	5	32	4
45	4	50	4	45	4	50	4	25	3
32	5	35	5	32	5	35	5	20	4
40	3	45	3	40	3	45	3	22	2
36	3	40	3	36	3	40	3	20	2
28	3	32	3	28	3	32	3	15	2
22	3	27	3	22	3	27	3	15	2

Application recommendations Multiplex

Order-Nr.
Ø-range
Tool material
Carbide type
Carbide grade
Surface

Tools with bold feed column no. are preferred choice.

Drill Ø mm	Feed column no.					
	1	2	3	4	5	6
	f (mm/rev.)					
10.00	0.08	0.09	0.11	0.14	0.19	0.24
12.50	0.09	0.11	0.13	0.17	0.22	0.28
16.00	0.11	0.13	0.16	0.21	0.27	0.34
20.00	0.13	0.15	0.19	0.25	0.32	0.40
25.00	0.16	0.18	0.23	0.29	0.38	0.48
31.50	0.19	0.22	0.27	0.35	0.45	0.57
40.00	0.23	0.26	0.33	0.42	0.54	0.69
50.00	0.27	0.31	0.39	0.50	0.64	0.82
63.00	0.32	0.38	0.47	0.60	0.77	0.98
102.00	0.40	0.48	0.59	0.74	0.85	1.20
150.00	0.59	0.70	0.87	1.09	1.25	1.76
100.00	0.78	0.93	1.16	1.45	1.67	2.35

Coolant:

- Air
- Neat oil
- Soluble oil

Material group	Material examples Figures in bold = material no. to DIN EN 10 027	Tensile strength MPa (N/mm ²)	Hardness	Coolant
Common structural steels	1.0035 S185(St33), 1.0486 P275N(StE285), 1.0345 P235GH(H1), 1.0425 P265GH(H2)	≤500		○
	1.0050 E295 (St50-2), 1.0070 E360 (St70-2), 1.8937 P500NH (WStE500)	≤1000		○
Free-cutting steels	1.0718 11SMnPb30 (9SMnPb28), 1.0736 11SMn37 (9SMn36)	≤850		○
	1.0727 46S20 (45S20), 1.0728 (60S20), 1.0757 46SPb20 (45SPb20)	≤1000		○
Unalloyed heat-treatable steels	1.0402 C22, 1.1178 C30E (Ck30)	≤700		○
	1.0503 C45, 1.1191 C45E (Ck45)	≤850		○
	1.0601 C60, 1.1221 C60E (Ck60)	≤1000		○
Alloyed heat-treatable steels	1.5131 50MnSi4, 1.7003 38Cr2, 1.7030 28Cr4	≤1000		○
	1.5710 36NiCr6, 1.7035 41Cr4, 1.7225 42CrMo4	≤1400		○
Unalloyed case hard. steels	1.0301 (C10), 1.1121 C10E (Ck10)	≤850		○
Alloyed case hardened steels	1.7276 10CrMo11, 1.5125 11MnSi6	≤1000		●
	1.5752 15NiCr13, 1.7131 16MnCr5, 1.7264 20CrMo5	≤1400		●
Nitriding steels	1.8504 34CrAl6	≤1000		○
	1.8519 31CrMoV9, 1.8550 34CrAlNi7	≤1400		●
Tool steels	1.1750 C75W, 1.2067 102Cr6, 1.2307 29CrMoV9	≤850		○
	1.2080 X210Cr12, 1.2083 X42Cr13, 1.2419 105WCr6, 1.2767 X45NiCrMo4	≤1400		○
High speed steels	1.3243 S 6-5-2-5, 1.3343 S 6-5-2, 1.3344 S 6-5-3	≤1400		●
Spring steels	1.5026 55Si7, 1.7176 55Cr3, 1.8159 51CrV4 (51CrV4)		≤350 HB	●
Hardened steels	-		≤48 HRC	●
			≤66 HRC	●
Stainless steels, sulphured	1.4005 X12CrS13, 1.4104 X14CrMoS17, 1.4105 X6CrMoS17, 1.4305 X8CrNiS18-9	≤900		●
austenitic	1.4301 X5CrNi18-10 (V2A), 1.4541 X6CrNiTi18-10, 1.4571 X6CrNiMoTi 17-12-2 (V4A)	≤1100		●
martensitic	1.4057 X20CrNi172 (X17CrNi16-2), 1.4122 X39CrMo17-1, 1.4521 X2CrMoTi18-2	≤1500		●
Cast iron	0.6010 EN-GJL-100 (GG10), 0.6020 EN-GJL-200 (GG20)		≤240 HB	○
	0.6025 EN-GJL-250 (GG25), 0.6035 EN-GJL-350 (GG35)		≤350 HB	○
Spheroidal graphite iron and malleable cast iron	0.7050 EN-GJS-500-7 (GGG50), 0.8035 EN-GJMW-350-4 (GTW35)		≤240 HB	○
	0.7070 EN-GJS-700-2 (GGG70), 0.8170 EN-GJMB-700-2 (GTS70)		≤350 HB	○
Chilled cast iron	-		≤350 HB	○
New cast materials GGV	EN-GJV250 (GGV25), EN-GJV350 (GGV35)		≤220 HB	○
	EN-GJV400 (GGV40), EN-GJV500 (GGV50), SiMo 6		≤300 HB	○
New cast materials ADI	EN-GJS-800-8 (ADI800), EN-GJS-1000-5 (ADI1000)	≤1000		○
	EN-GJS-1200-2 (ADI1200), EN-GJS-1400-1 (ADI1400)	≤1400		○
Special alloys	Nimonic, Inconel, Monel, Hastelloy	≤2000		●
Ti and Ti-alloys	3.7024 Ti99,5, 3.7114 TiAl5Sn2,5, 3.7124 TiCu2	≤850		●
	3.7154 TiAl6Zr5, 3.7165 TiAl6V4, 3.7184 TiAl4Mo4Sn2,5, - TiAl8Mo1V1	≤1400		●
Aluminium and Al-alloys	3.0255 Al99,5, 3.2315 AlMgSi1, 3.3515 AlMg1	≤400		○
Al wrought alloys	3.0615 AlMgSiPb, 3.1325 AlCuMg1, 3.3245 AlMg3Si, 3.4365 AlZnMgCu1,5	≤650		○
Al cast alloys ≤ 10 % Si	3.2131 G-AlSi5Cu1, 3.2153 G-AlSi7Cu3, 3.2573 G-AlSi9	≤600		○
≤ 24 % Si	3.2581 G-AlSi12, 3.2583 G-AlSi12Cu, - G-AlSi12CuNiMg	≤600		○
Magnesium alloys	3.5200 MgMn2, 3.5812.05 G-MgAl8Zn1, 3.5612.05 G-MgAl6Zn1	≤400		○
Copper, low-alloyed	2.0070 SE-Cu, 2.1020 CuSn6, 2.1096 G-CuSn5ZnPb	≤600		○
Brass, short-chipping	2.0380 CuZn39Pb2, 2.0401 CuZn39Pb3, 2.0410 CuZn43Pb2	≤600		○
long-chipping	2.0250 CuZn20, 2.0280 CuZn33, 2.0332 CuZn37Pb0,5	≤600		○
Bronze, short-chipping	2.1090 CuSn7ZnPb, 2.1170 CuPb5Sn5, 2.1176 CuPb10Sn	≤600		○
	2.0790 CuNi18Zn19Pb	≤850		○
Bronze, long-chipping	2.0916 CuAl5, 2.0960 CuAl9Mn, 2.1050 CuSn10	≤850		○
	2.0980 CuAl11Ni, 2.1247 CuBe2	≤1000		○
Duroplastics	Bakelit, Resopal, Pertinax, Moltopren	≤150		○
Thermoplastics	Plexiglass, Hostalen, Novodur, Makralon	≤100		○
Kevlar	Kevlar	≤1000		○
Glass, carbon concentr. plastics	GFK/CFK	≤1000		○



HARTNER

86708	86709
10-35	10-35
Solid carbide	Solid carbide
H22	H22
K20/K40	K20/K40
T	T

86701	86702
10-35	10-35
Solid carbide	Solid carbide
H22	H22
K20/K40	K20/K40
F	F

86711
10-65
Solid carbide
H22
K20/K40
○

Article no. 86709/86701 without chamfer
for materials with tensile strength up to 600 N/mm²

Article no. 86708/86702 with chamfer
for materials with tensile strength over 600 N/mm²



v_c m/min	Feed column no.
60	5
55	4
100	4
95	4
80	4
80	4
75	3
70	4
60	3
85	4
70	4
55	3
60	3
50	2
40	3
35	2
40	2
35	2
25	1
40	2
25	2
100	5
90	4
80	4
65	3
25	1
180	5
160	5
140	5
130	5
150	5
70	4
160	5
110	4
80	5
65	4
45	4
35	4
70	3
70	3
70	3
70	3

v_c m/min	Feed column no.
70	5
65	4
115	4
105	4
90	4
90	4
85	3
80	4
70	3
95	4
80	4
65	3
65	3
55	2
45	3
40	2
45	2
40	2
30	1
45	2
30	2
120	5
105	4
90	4
75	3
30	1
180	5
160	5
140	5
130	5
150	5
70	4
160	5
110	4
80	5
65	4
45	4
35	4
70	3
70	3
70	3
70	3

v_c m/min	Feed column no.
180	5
160	5
140	5
130	5
150	4
70	5
160	4
110	5
80	4
65	4
45	4
35	4
70	3
70	3
70	3
70	3



Interchangeable insert 86609 is made from PM HSS

Point angle for insert diameter

- ≤ Ø 25.4 = 135°
- > Ø 25.4 = 132°
- > Ø 66.0 = 140°
- > Ø 190.0 = 150°

The insert has an optimised geometry and AlTiN-coating for an improved chip formation, longer tool life and reduced wear.

The V-form chip breakers reduce the jamming of chips and therefore increase the tool life of the insert.

Application range:

Steel, cast iron, high heat resistant alloys

Advantages:

- improved chip formation
- increased tool life (thanks to corner chamfer) and reduced corner wear and reduced burr formation especially on 'break through'
- improved heat dissipation and reduced wear thanks to corner chamfer
- higher cutting speeds and longer tool life achievable thanks to new HSS-E-PM (≤ Ø 66.0mm; > Ø 66.0 mm: HSS-E)

Margin for carbide inserts Ø 10.0 - 35 mm and HSS-E-PM inserts Ø 10.0 - 25.4 mm

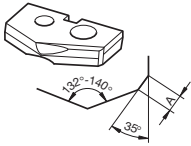

Insert diameter	Margin A
Ø 10.0 - 13.4	0.25 ±0.05
Ø 13.5 - 18.9	0.30 ±0.05
Ø 19.0 - 25.4	0.35 ±0.05
Ø 25.5 - 35.0	0.40 ±0.05

Please note:

As Multiplex tools are predominantly guided by the chisel edge, they are not suitable for the drilling of pre-cast or pre-drilled holes!

Further details can be found in the chapter „Tips and Tricks“ on page 45.

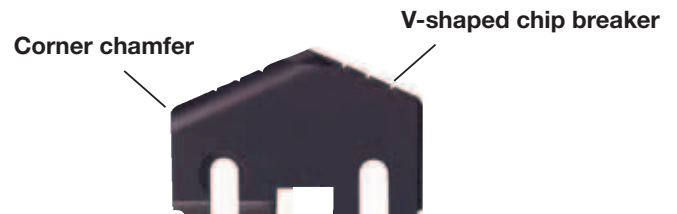

ISO code

P	Steel, high-alloyed steel
M	Stainless steel
K	Grey cast iron, spher. graphite iron/malleable cast iron
N	Aluminium and other non-ferrous metals
S	Special, super and titanium alloys
H	Hardened steel and chilled cast iron

Pictograms

Tool material	VHM Solid carbide	HSS-E-PM High-speed steel	HSS-E High-speed steel				
Surface	AITiN	bright	browned	steam tempered	FIRE	nickel-plated	TiN
Drilling depth	3xD	5xD	7xD				
Standard	WN	to Hartner standard					
Point angle	132°	135°	180°				
Shank from	-HB to DIN 6535	Cyl cylindrical	MK Morse Taper	SK Taper shank	MAS-BT MAS-BT		
Web thinning	with web thinning						
Cutting direction	R right	L left					
Internal coolant	with IC	without IC					



THE HARTNER PROGRAMME



▼ FU 500 / FN 500



▼ GUN DRILLS



▼ INOX DRILLS



▼ MICRO-PRECISION DRILLS



▼ THREADING TOOLS



▼ TS-DRILLS



▼ TF 100 MULTI-MILL



▼ SOLID CARBIDE
MILLING CUTTERS



▼ CHAMFERING
MILLING CUTTERS



▼ MULTIPLEX



▼ MULTIPLEX HPC



▼ TM VENDING MACHINES

HARTNER GMBH

P.O. Box 10 04 27 | 72425 Albstadt | Germany
Tel. +49 74 31 125-0 | Fax +49 74 31 125-21 547

www.hartner.de

No liability can be accepted for printing errors or technical changes of any kind.
Our Conditions of Sale and Terms of Payment apply. Available on request.

118 185/22002-III-06 | Printed in Germany | 2022

